

F-7 AETNA

Thrust ball bearings

TYPE: Ball bearings, Thrust ball bearing, Single direction, Separable, inch size

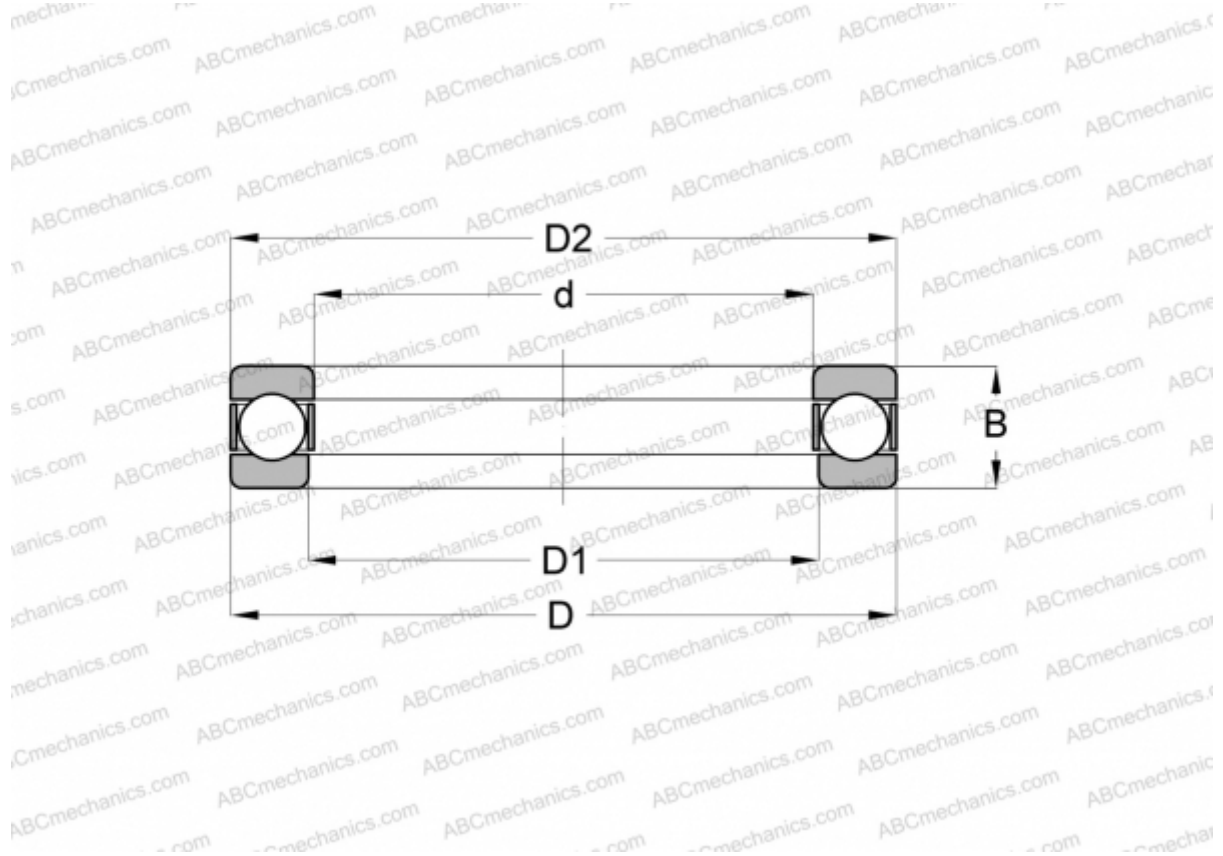

Technical specification

DIMENSIONS, MM

d	22,225
D	46,830
D1	23,018
B	15,875

WEIGHT, KG 0,124

MANUFACTURER [AETNA](#)

INTERCHANGE

ABC	GT-7
INA	GT-7
ANDREWS	GT-7
NICE	1007