

## 1012 NICE

Thrust ball bearings

TYPE: Ball bearings, Thrust ball bearing, Single direction, Separable, inch size

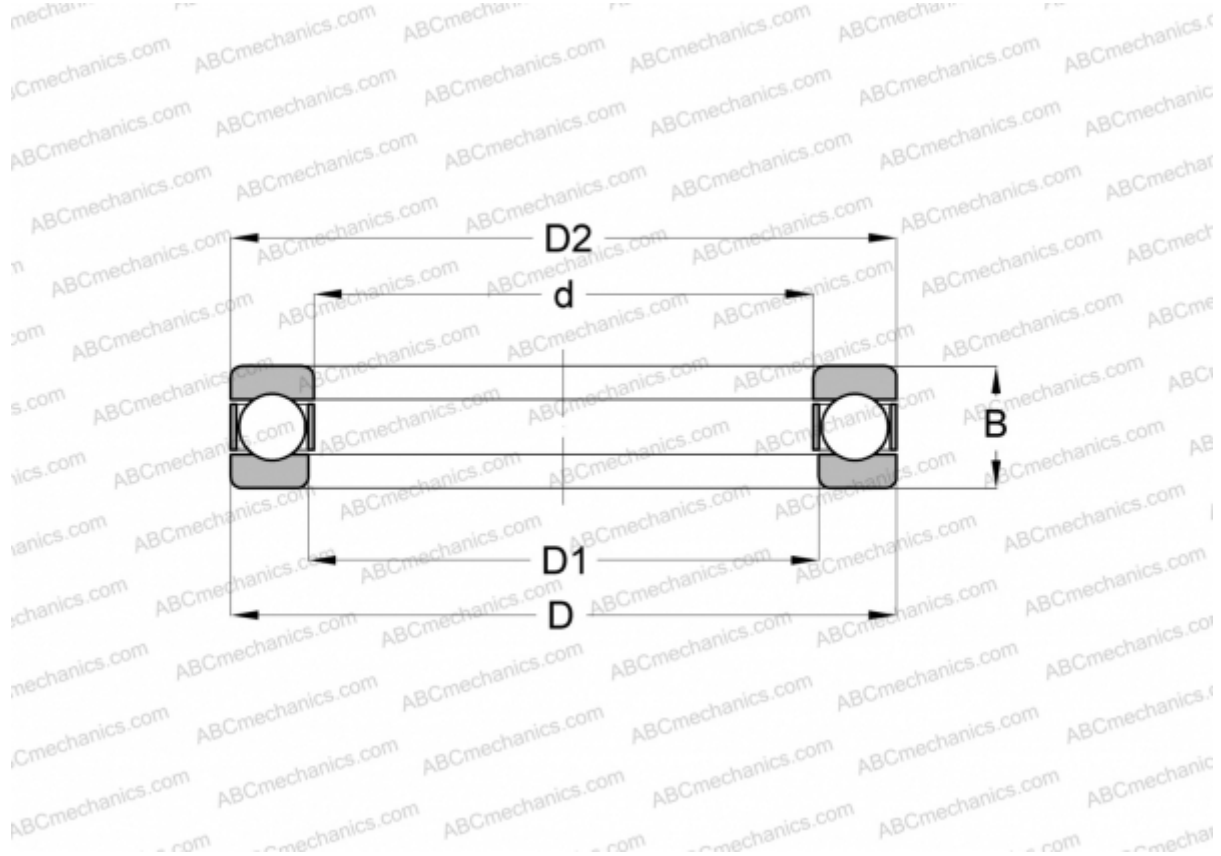

### Technical specification

#### DIMENSIONS, MM

d	30,193
D	53,180
D1	30,955
B	15,875

**WEIGHT, KG** 0,142

**MANUFACTURER** [NICE](#)

#### INTERCHANGE

ABC	<a href="#">GT-12</a>
INA	<a href="#">GT-12</a>
AETNA	<a href="#">F-12</a>
ANDREWS	<a href="#">GT-12</a>