

4102 INA

Thrust ball bearings

TYPE: Ball bearings, Thrust ball bearing, Single direction, Separable, angular adjustment facility series 41/5

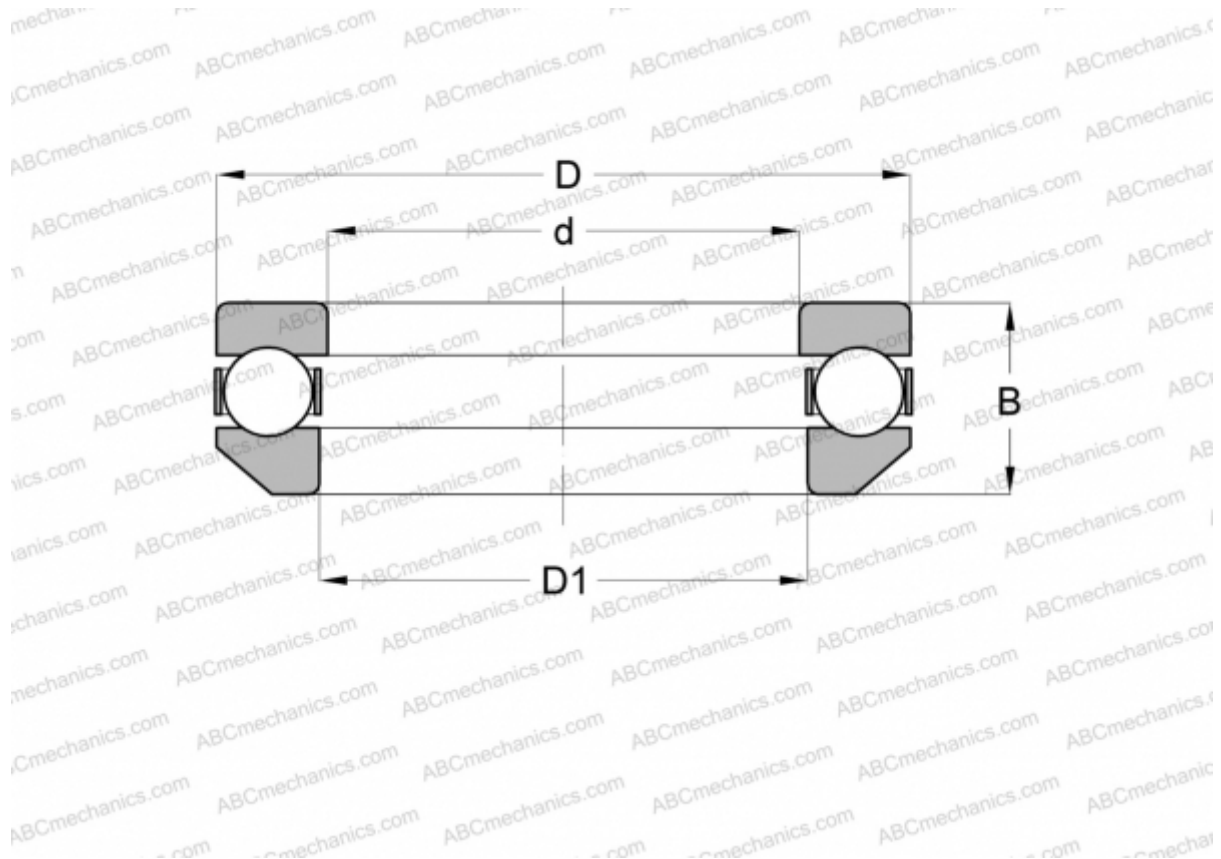

Technical specification

DIMENSIONS, MM

d	15,000
D	35,000
D1	16,993
B	15,000

WEIGHT, KG 0,070

MANUFACTURER [INA](#)