

4105 INA

Thrust ball bearings

TYPE: Ball bearings, Thrust ball bearing, Single direction, Separable, angular adjustment facility series 41/5

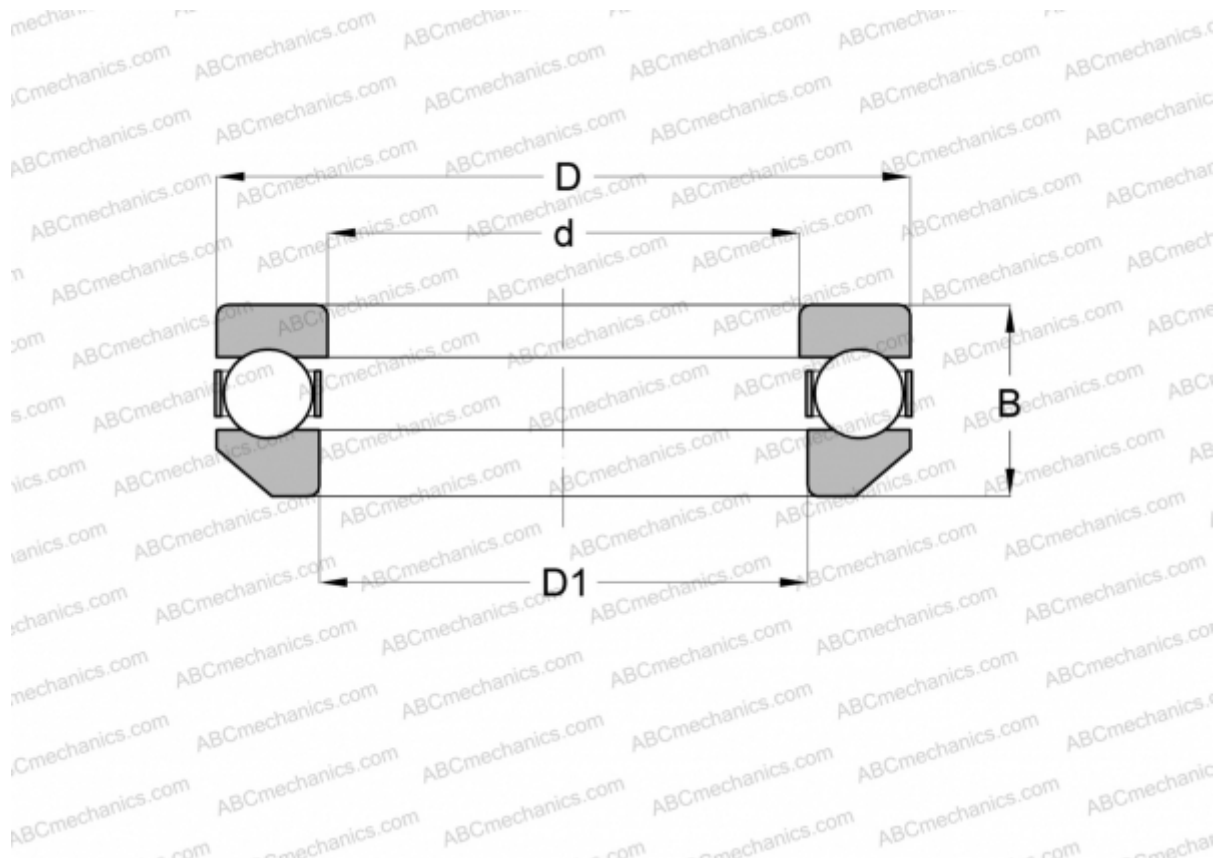

Technical specification

DIMENSIONS, MM

d	25,000
D	48,000
D1	27,000
B	17,000

WEIGHT, KG 0,133

MANUFACTURER [INA](#)