

4107 INA

Thrust ball bearings

TYPE: Ball bearings, Thrust ball bearing, Single direction, Separable, angular adjustment facility series 41/5

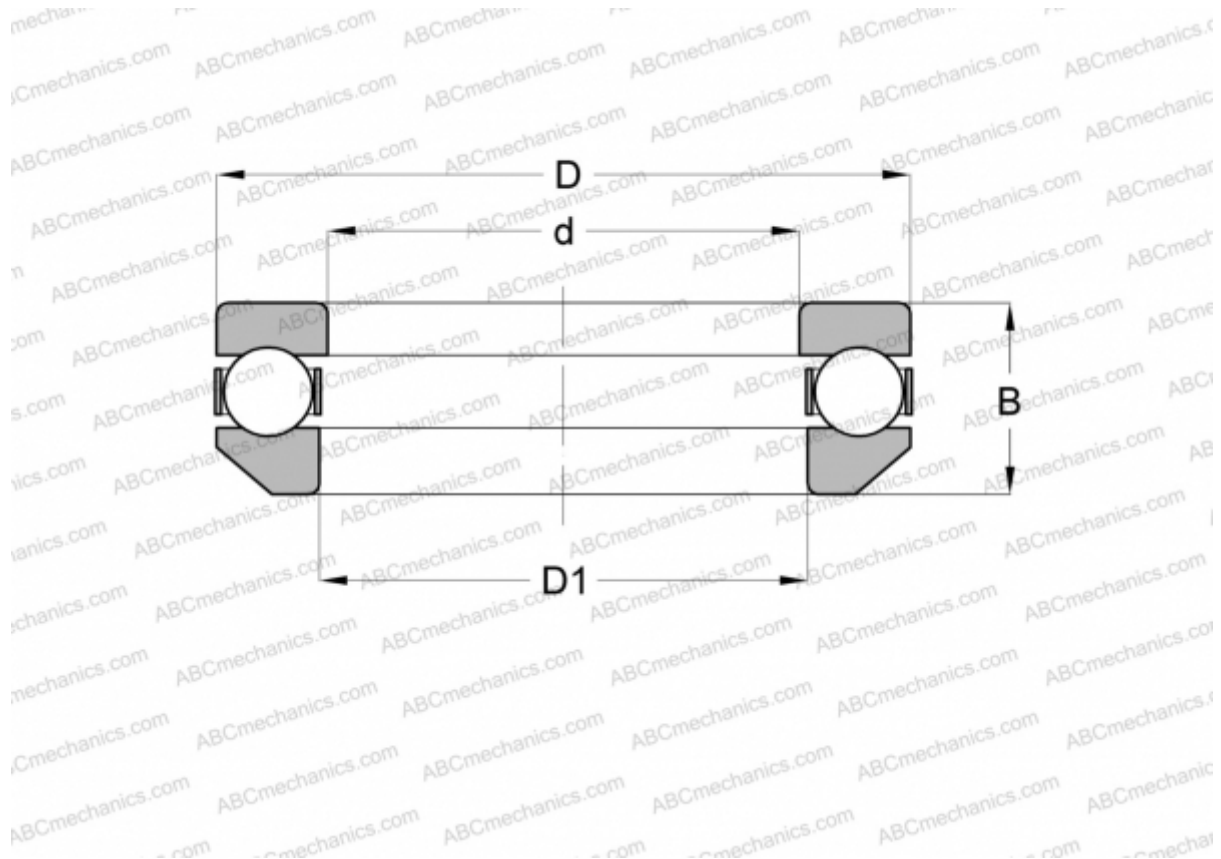

Technical specification

DIMENSIONS, MM

d	35,000
D	62,000
D1	37,008
B	21,000

WEIGHT, KG 0,255

MANUFACTURER [INA](#)