

4108 INA

Thrust ball bearings

TYPE: Ball bearings, Thrust ball bearing, Single direction, Separable, angular adjustment facility series 41/5

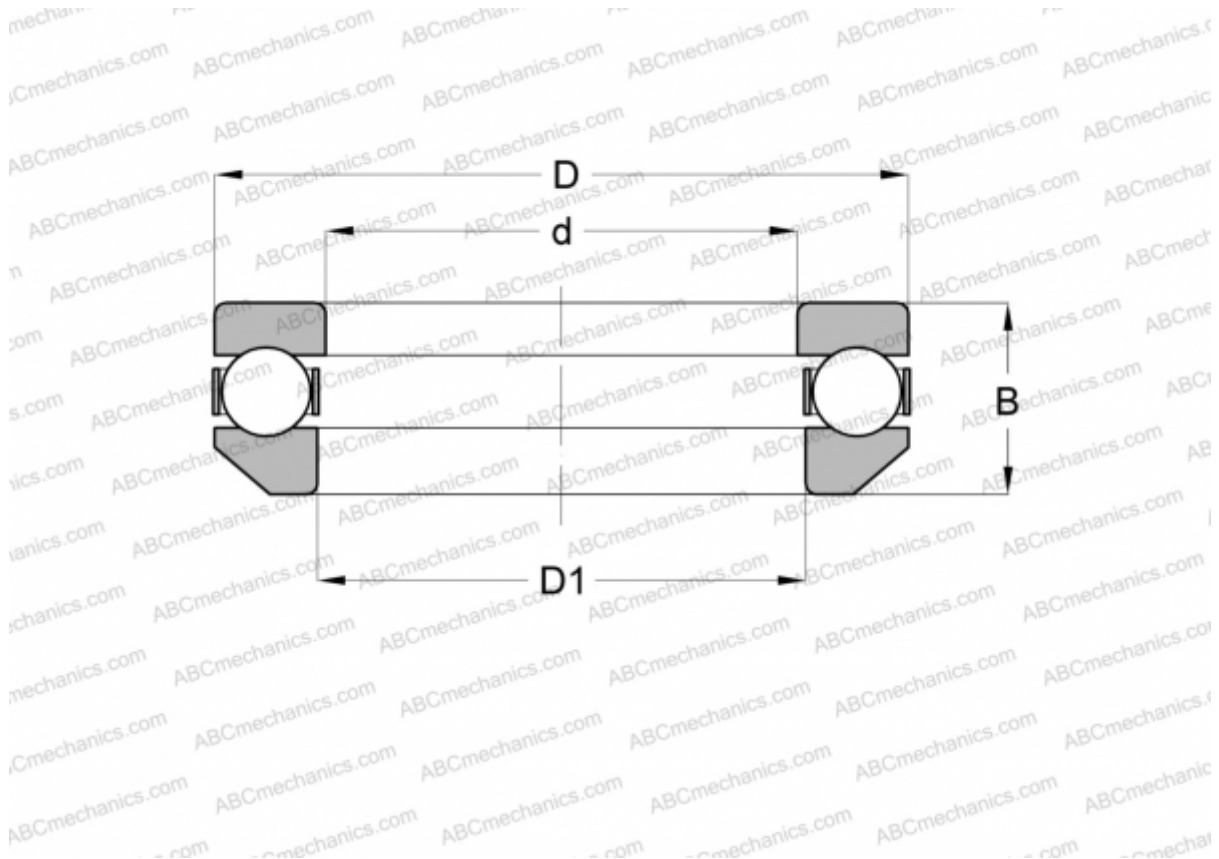

Technical specification

DIMENSIONS, MM

d	40,000
D	64,000
D1	42,012
B	21,000

WEIGHT, KG 0,222

MANUFACTURER [INA](#)