

4109 INA

Thrust ball bearings

TYPE: Ball bearings, Thrust ball bearing, Single direction, Separable, angular adjustment facility series 41/5

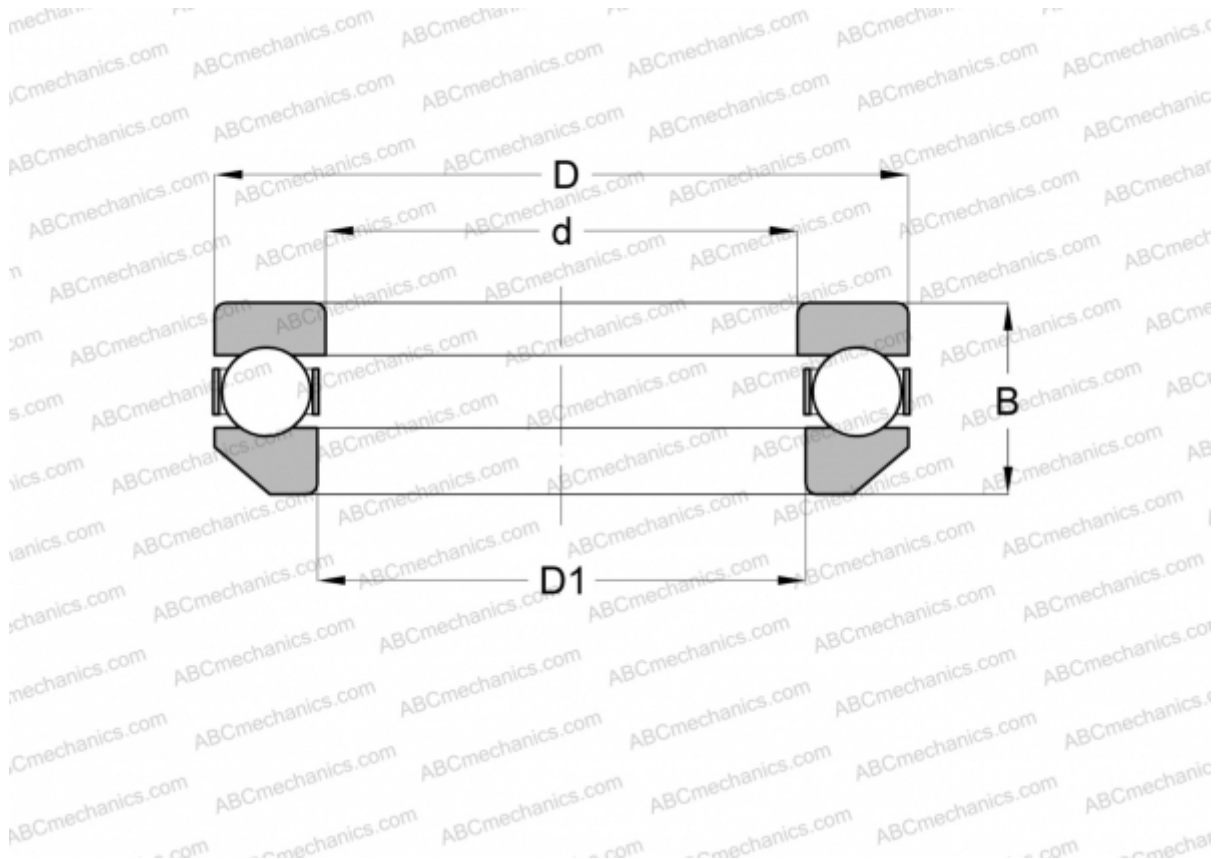

Technical specification

DIMENSIONS, MM

d	45,000
D	73,000
D1	46,990
B	25,000

WEIGHT, KG 0,408

MANUFACTURER [INA](#)