

4111 INA

Thrust ball bearings

TYPE: Ball bearings, Thrust ball bearing, Single direction, Separable, angular adjustment facility series 41/5

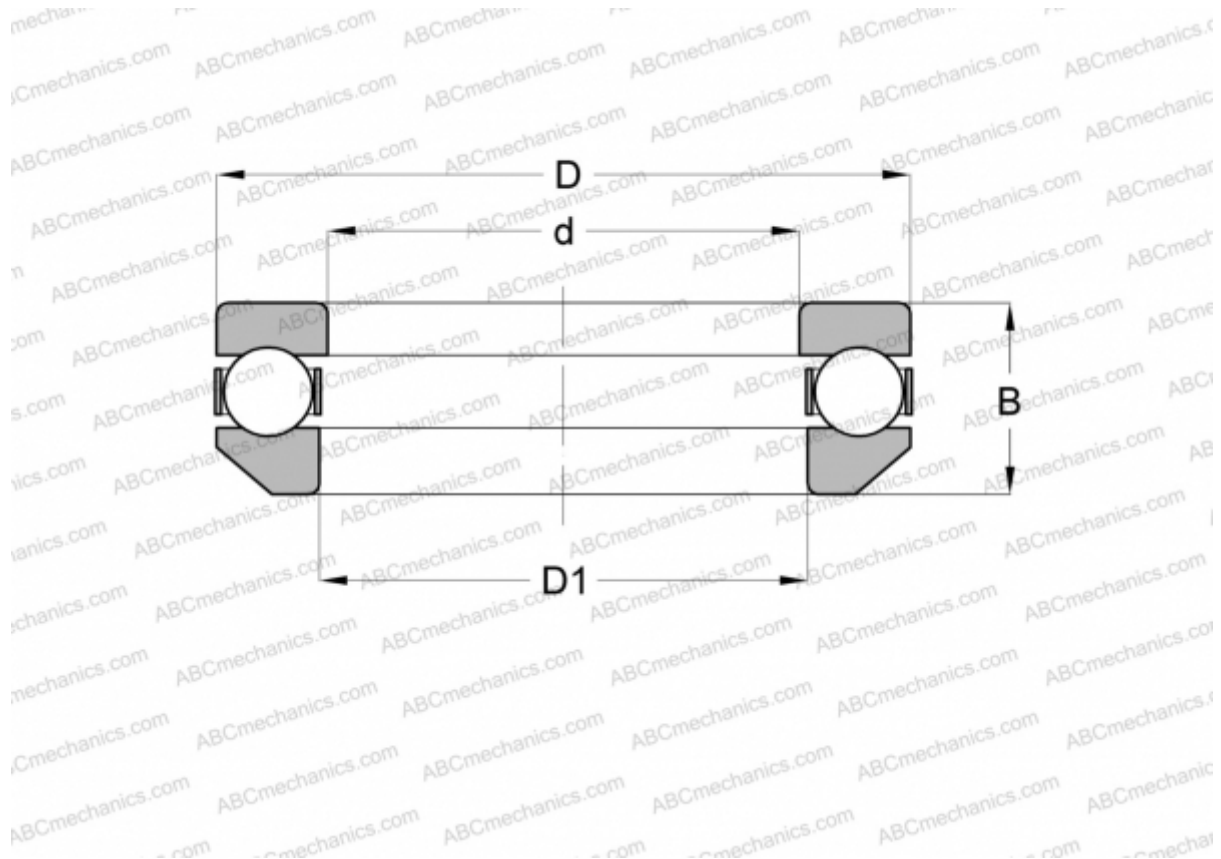

Technical specification

DIMENSIONS, MM

d	55,000
D	88,000
D1	56,998
B	28,000

WEIGHT, KG 0,645

MANUFACTURER [INA](#)