

## 4113 INA

Thrust ball bearings

TYPE: Ball bearings, Thrust ball bearing, Single direction, Separable, angular adjustment facility series 41/5

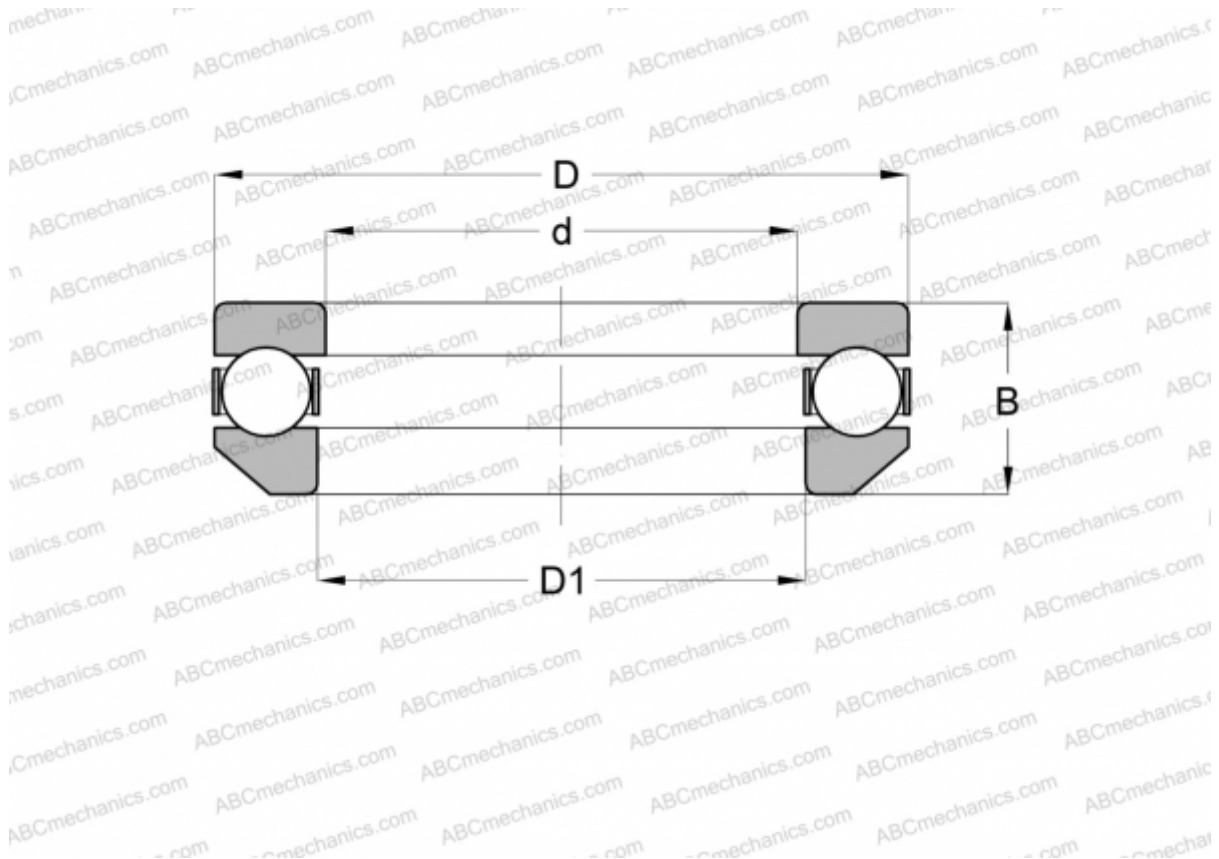

### Technical specification

#### DIMENSIONS, MM

d	65,000
D	100,000
D1	67,005
B	32,000

**WEIGHT, KG** 0,900

**MANUFACTURER** [INA](#)