

## 4114 INA

Thrust ball bearings

TYPE: Ball bearings, Thrust ball bearing, Single direction, Separable, angular adjustment facility series 41/5

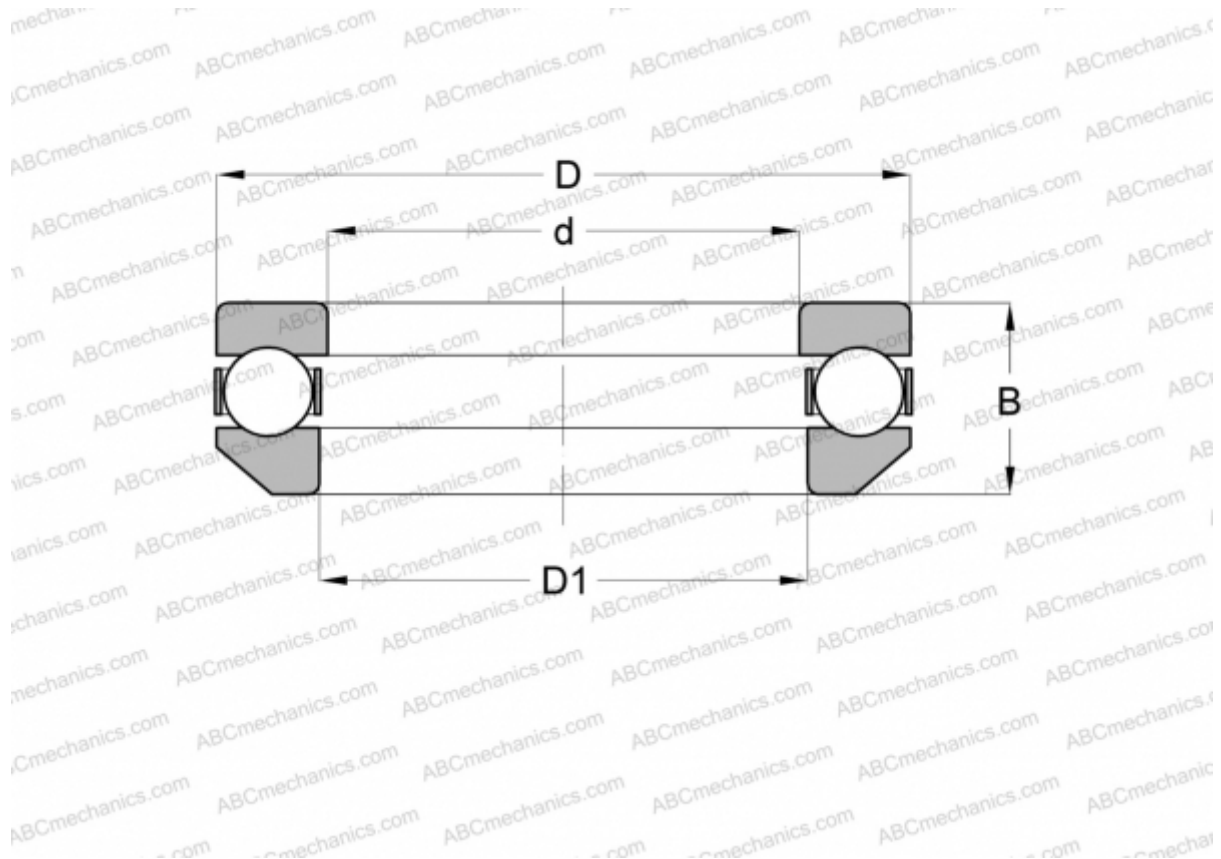

### Technical specification

#### DIMENSIONS, MM

d	70,000
D	103,000
D1	72,009
B	32,000

**WEIGHT, KG** 0,816

**MANUFACTURER** [INA](#)