

4115 INA

Thrust ball bearings

TYPE: Ball bearings, Thrust ball bearing, Single direction, Separable, angular adjustment facility series 41/5

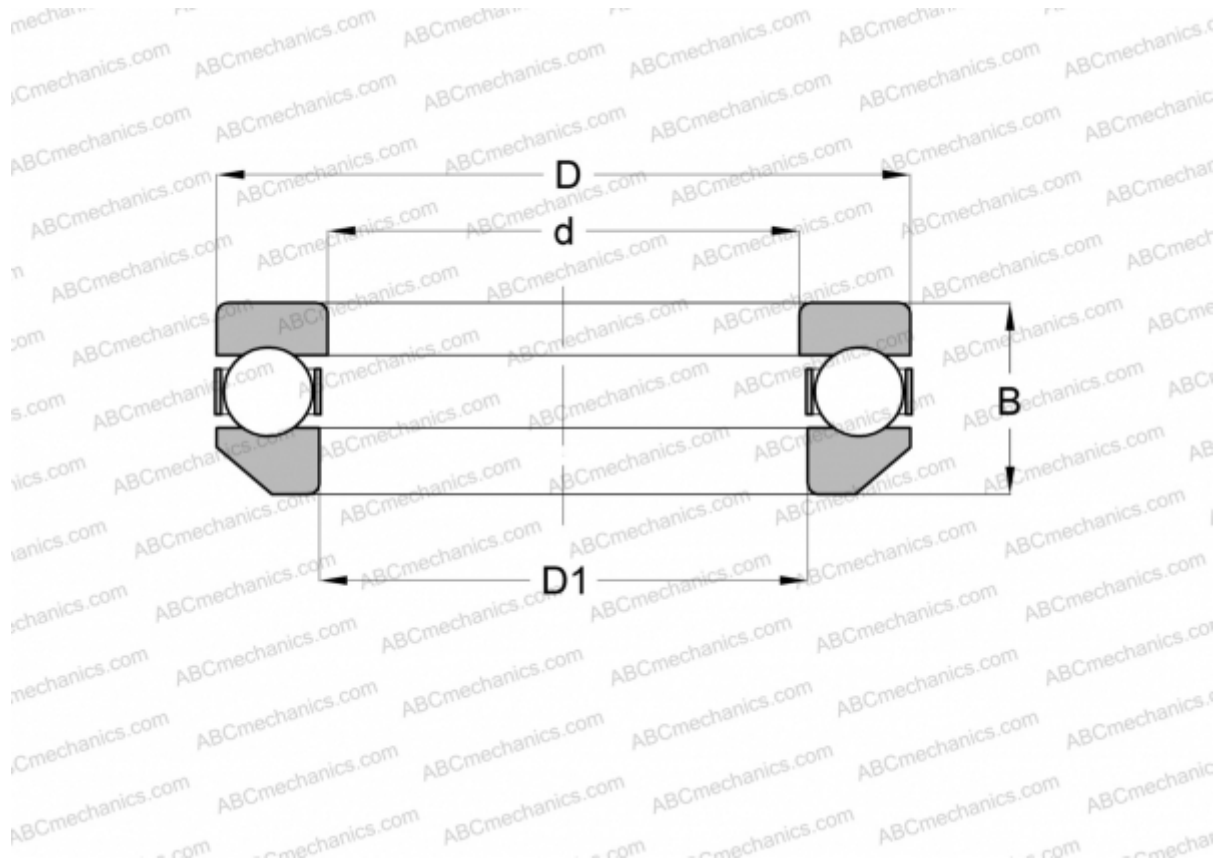

Technical specification

DIMENSIONS, MM

d	75,000
D	110,000
D1	77,013
B	32,000

WEIGHT, KG 1,026

MANUFACTURER [INA](#)