

4116 INA

Thrust ball bearings

TYPE: Ball bearings, Thrust ball bearing, Single direction, Separable, angular adjustment facility series 41/5

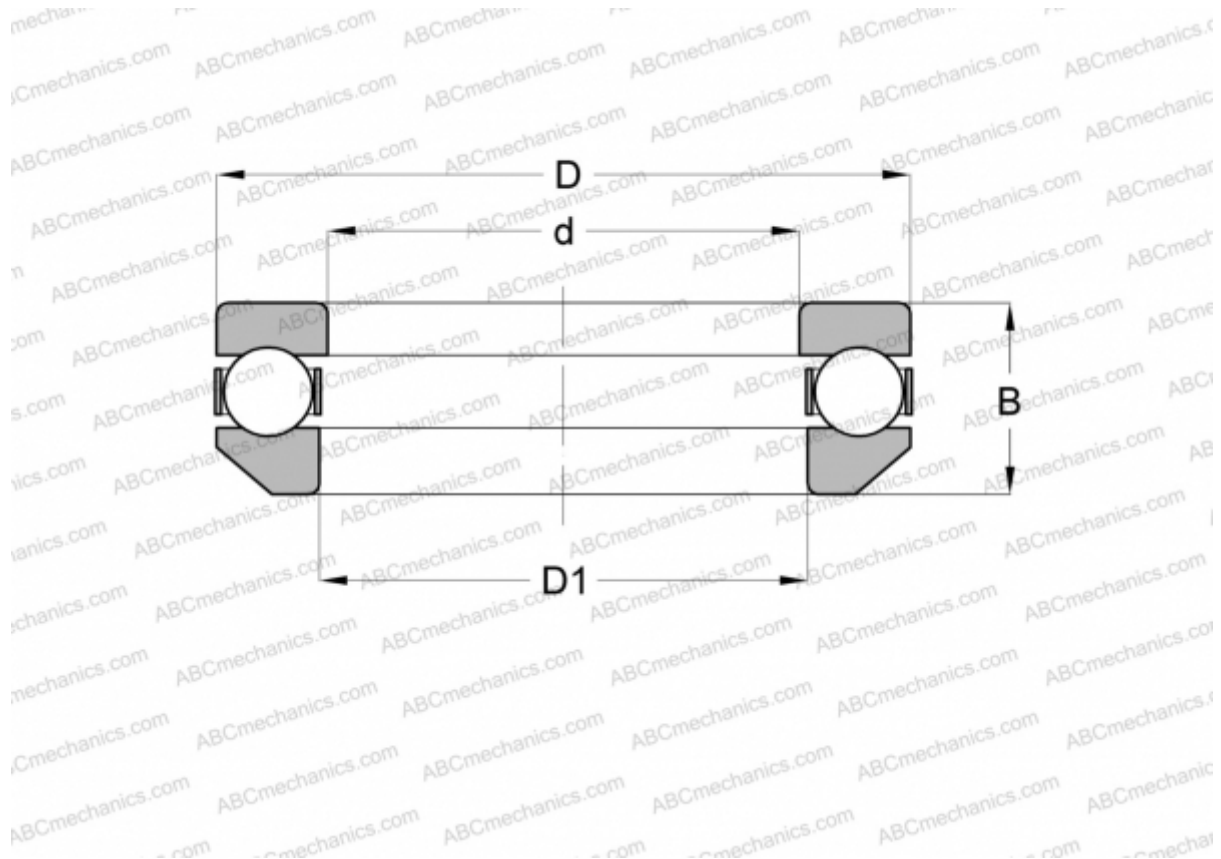

Technical specification

DIMENSIONS, MM

d	80,000
D	115,000
D1	81,991
B	35,000

WEIGHT, KG 1,043

MANUFACTURER [INA](#)