

## 4117 INA

Thrust ball bearings

TYPE: Ball bearings, Thrust ball bearing, Single direction, Separable, angular adjustment facility series 41/5

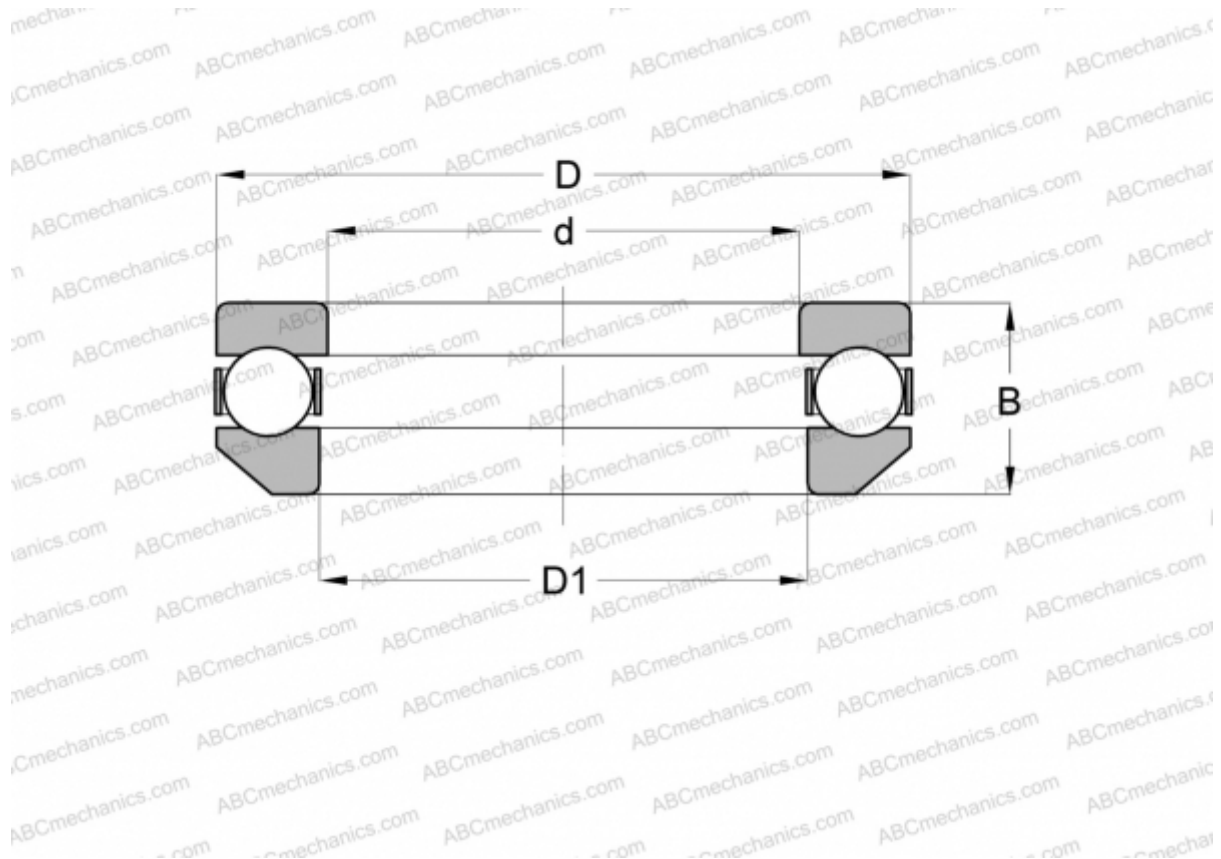

### Technical specification

#### DIMENSIONS, MM

d	85,000
D	125,000
D1	88,011
B	38,000

**WEIGHT, KG** 1,584

**MANUFACTURER** [INA](#)