

4118 INA

Thrust ball bearings

TYPE: Ball bearings, Thrust ball bearing, Single direction, Separable, angular adjustment facility series 41/5

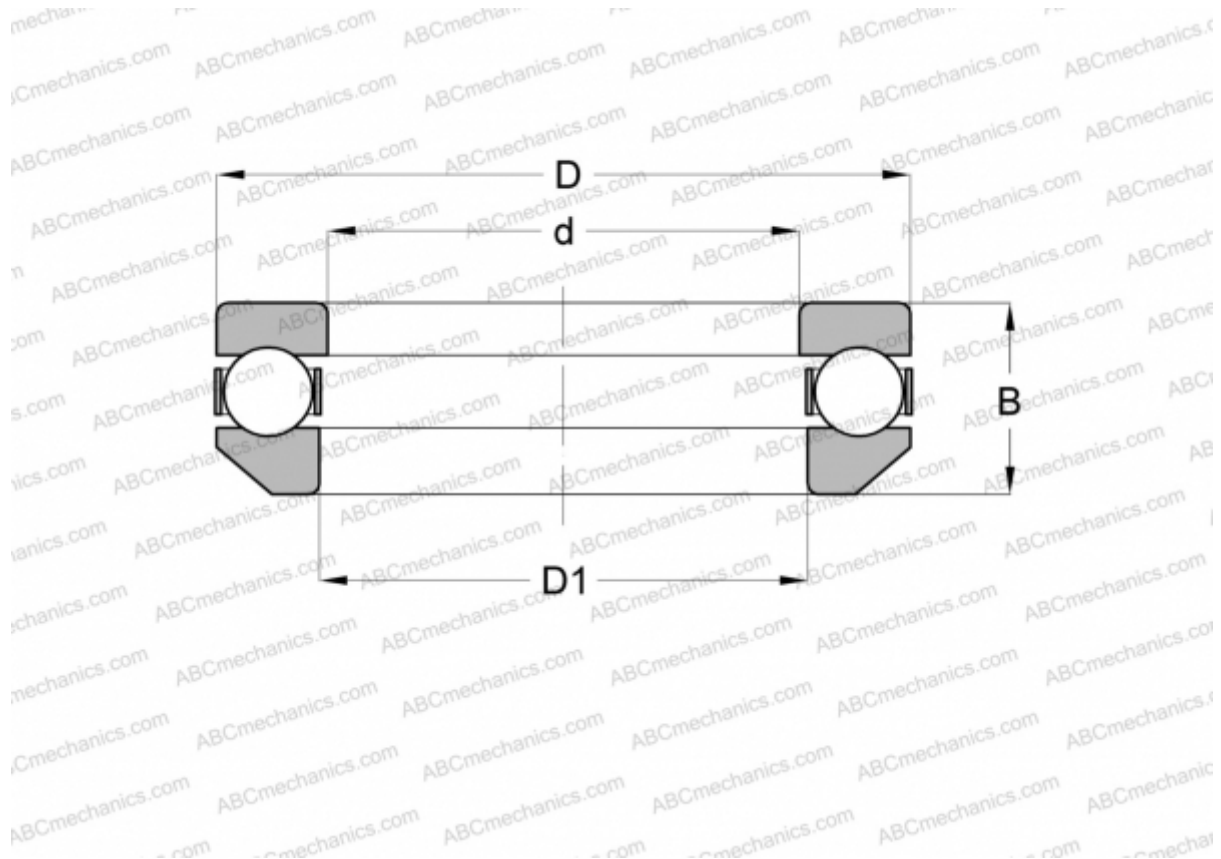

Technical specification

DIMENSIONS, MM

d	90,000
D	135,000
D1	93,015
B	38,000

WEIGHT, KG 1,633

MANUFACTURER [INA](#)