

4120 INA

Thrust ball bearings

TYPE: Ball bearings, Thrust ball bearing, Single direction, Separable, angular adjustment facility series 41/5

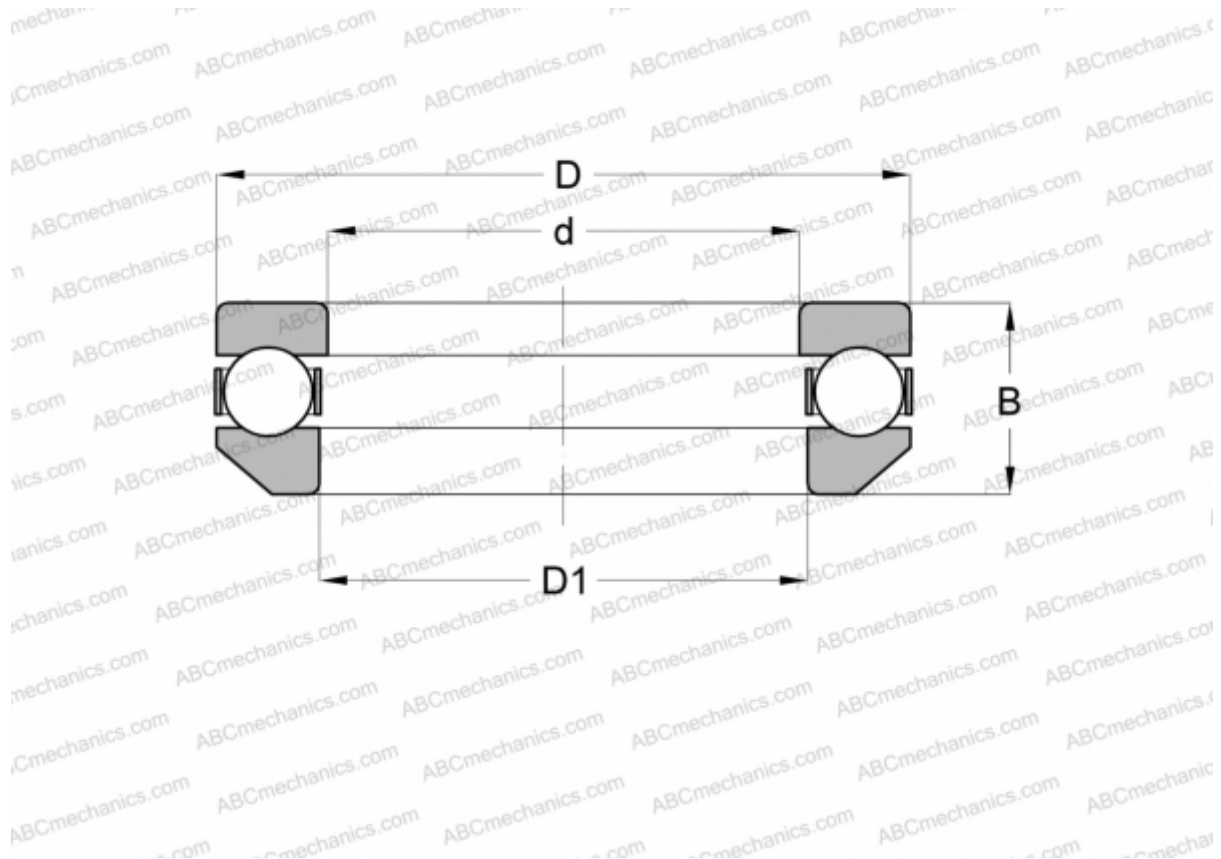

Technical specification

DIMENSIONS, MM

d	100,000
D	150,000
D1	102,997
B	41,000

WEIGHT, KG 2,222

MANUFACTURER [INA](#)