

4121 INA

Thrust ball bearings

TYPE: Ball bearings, Thrust ball bearing, Single direction, Separable, angular adjustment facility series 41/5

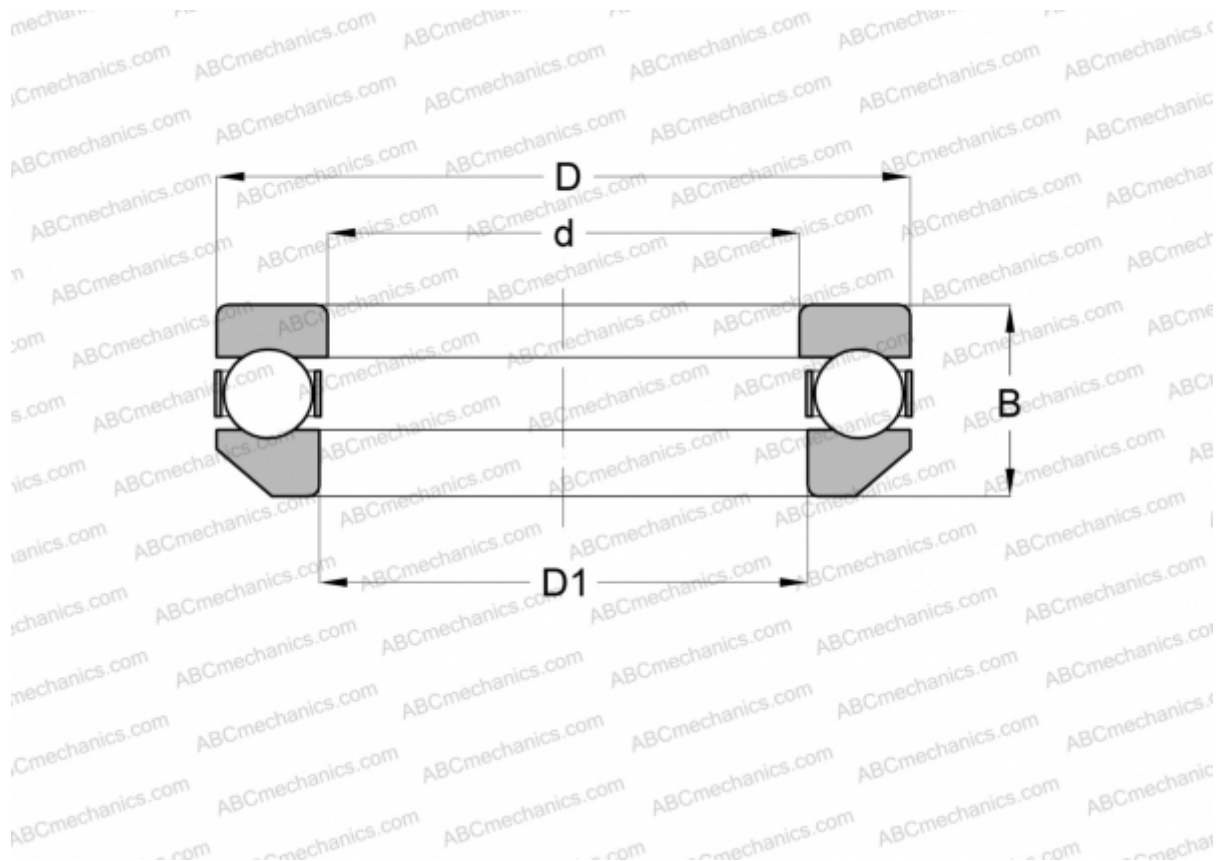

Technical specification

DIMENSIONS, MM

d	105,000
D	155,000
D1	108,001
B	46,000

WEIGHT, KG 2,937

MANUFACTURER [INA](#)