

4122 INA

Thrust ball bearings

TYPE: Ball bearings, Thrust ball bearing, Single direction, Separable, angular adjustment facility series 41/5

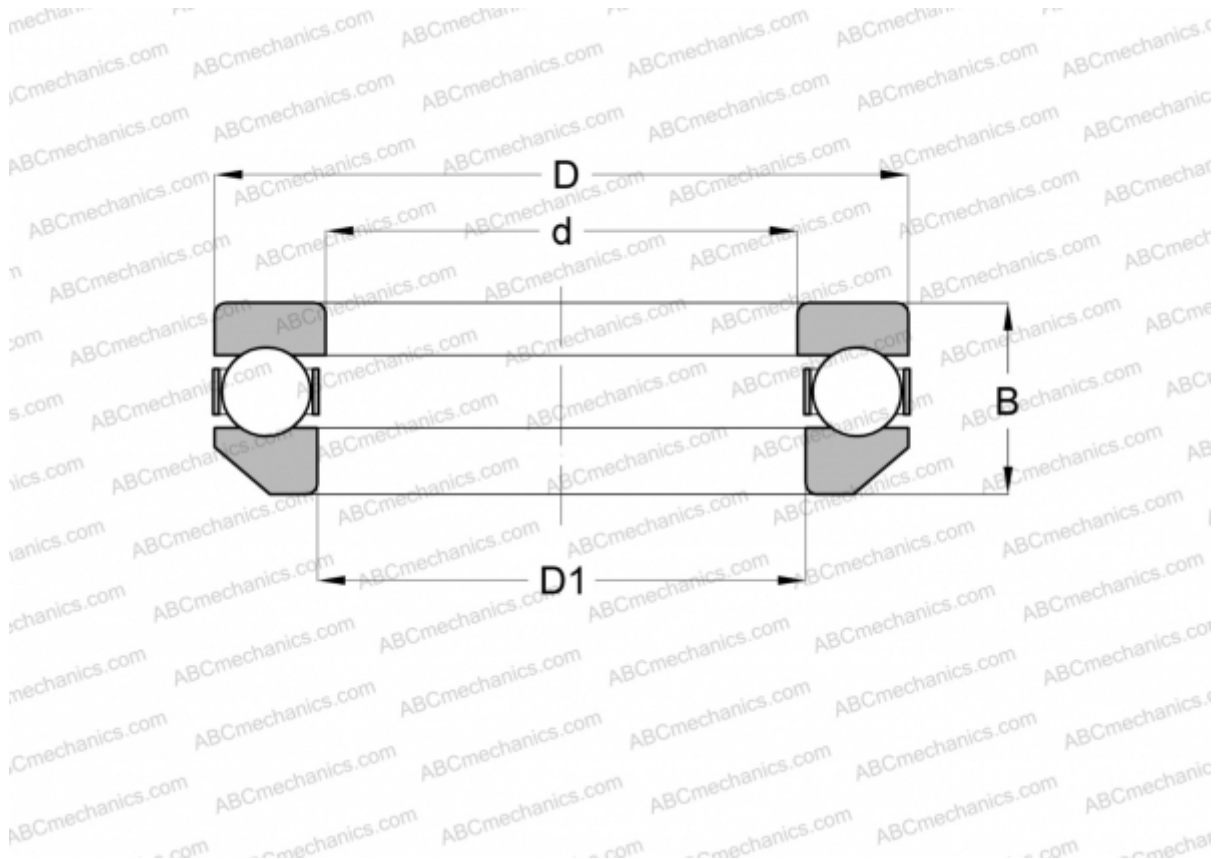

Technical specification

DIMENSIONS, MM

d	110,000
D	160,000
D1	113,005
B	46,000

WEIGHT, KG 3,084

MANUFACTURER [INA](#)