

4130 INA

Thrust ball bearings

TYPE: Ball bearings, Thrust ball bearing, Single direction, Separable, angular adjustment facility series 41/5

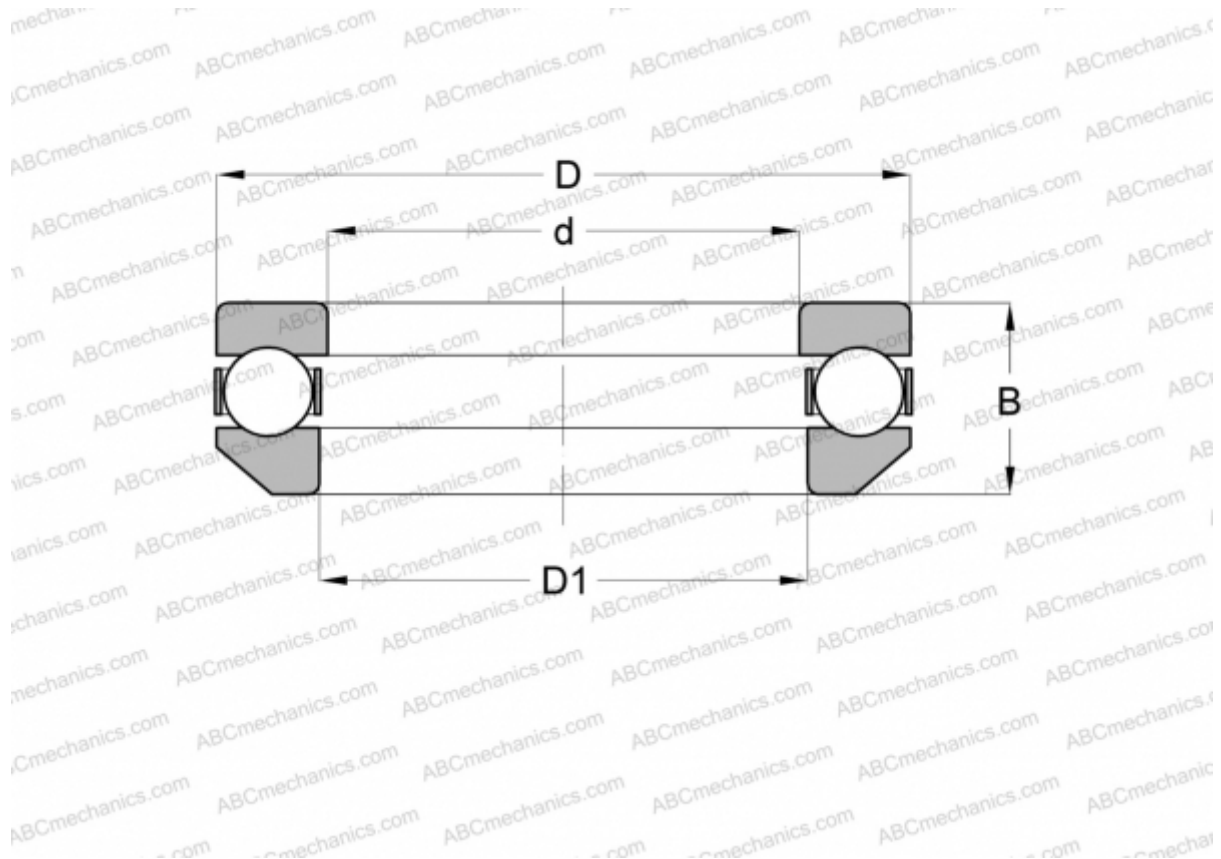

Technical specification

DIMENSIONS, MM

d	150,000
D	220,000
D1	154,000
B	60,000

WEIGHT, KG 7,483

MANUFACTURER [INA](#)