

4132 INA

Thrust ball bearings

TYPE: Ball bearings, Thrust ball bearing, Single direction, Separable, angular adjustment facility series 41/5

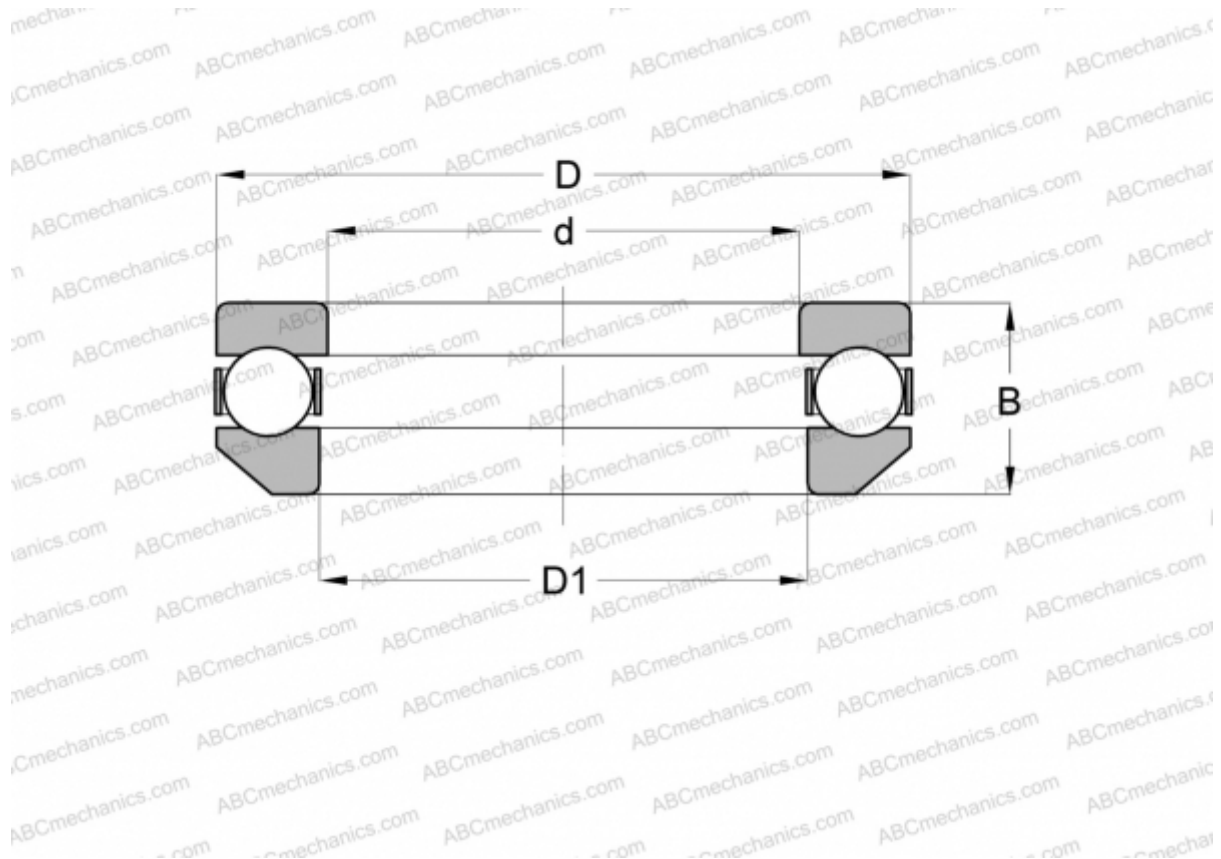

Technical specification

DIMENSIONS, MM

| | |
|----|---------|
| d | 160,000 |
| D | 235,000 |
| D1 | 164,008 |
| B | 65,000 |

WEIGHT, KG 9,483

MANUFACTURER [INA](#)