

4140 INA

Thrust ball bearings

TYPE: Ball bearings, Thrust ball bearing, Single direction, Separable, angular adjustment facility series 41/5

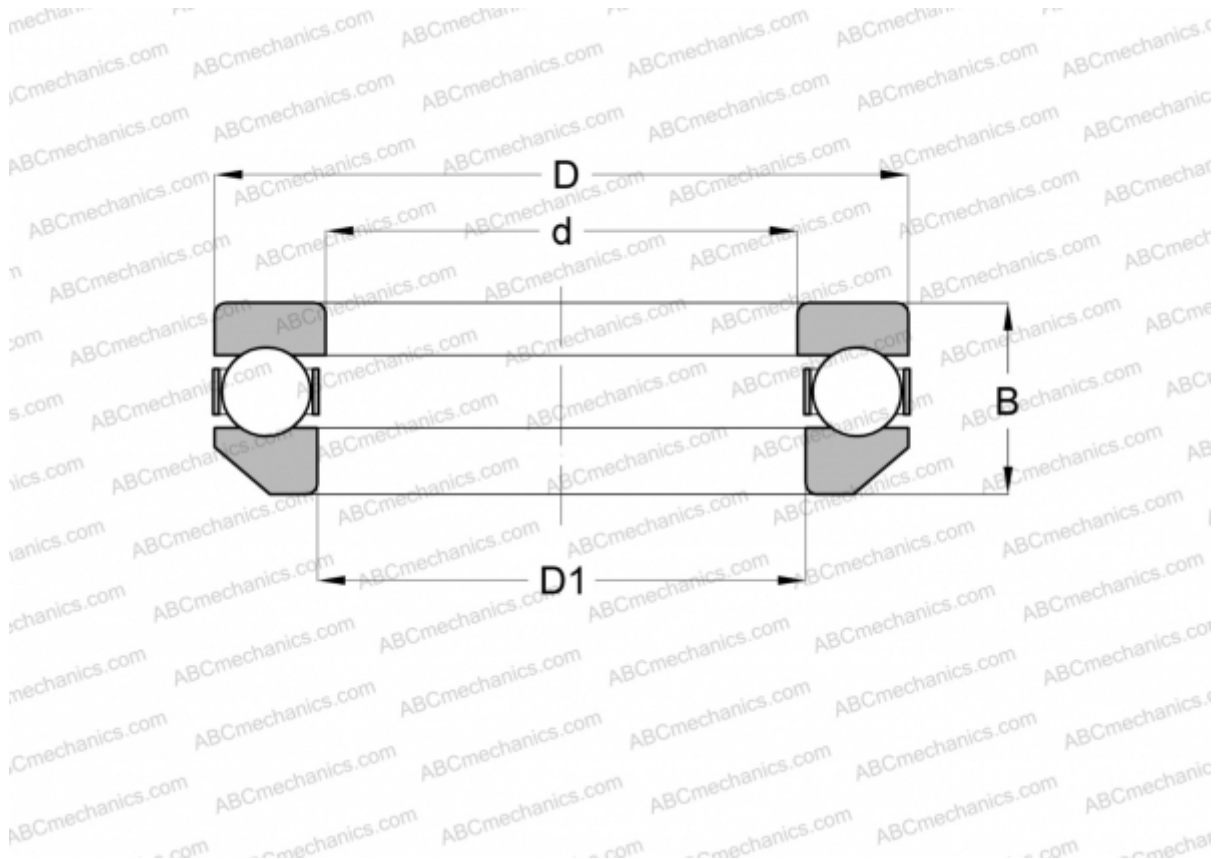

Technical specification

DIMENSIONS, MM

d	200,000
D	290,000
D1	210,871
B	80,000

WEIGHT, KG 17,414

MANUFACTURER [INA](#)