

## 502 INA

Thrust ball bearings

TYPE: Ball bearings, Thrust ball bearing, Single direction, Separable, angular adjustment facility series 41/5

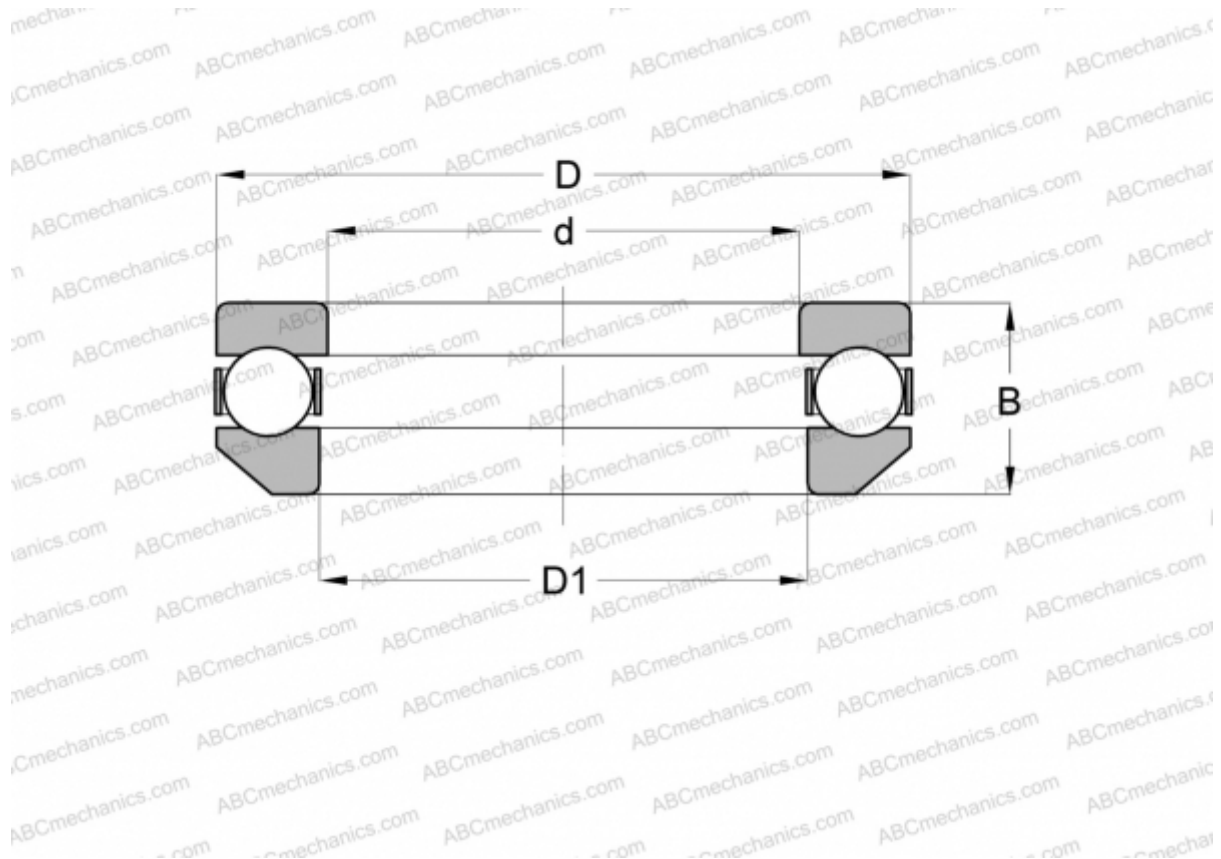

### Technical specification

#### DIMENSIONS, MM

d	15,000
D	35,000
D1	17,000
B	20,000

**WEIGHT, KG** 0,123

**MANUFACTURER** [INA](#)