

## 503 INA

Thrust ball bearings

TYPE: Ball bearings, Thrust ball bearing, Single direction, Separable, angular adjustment facility series 41/5

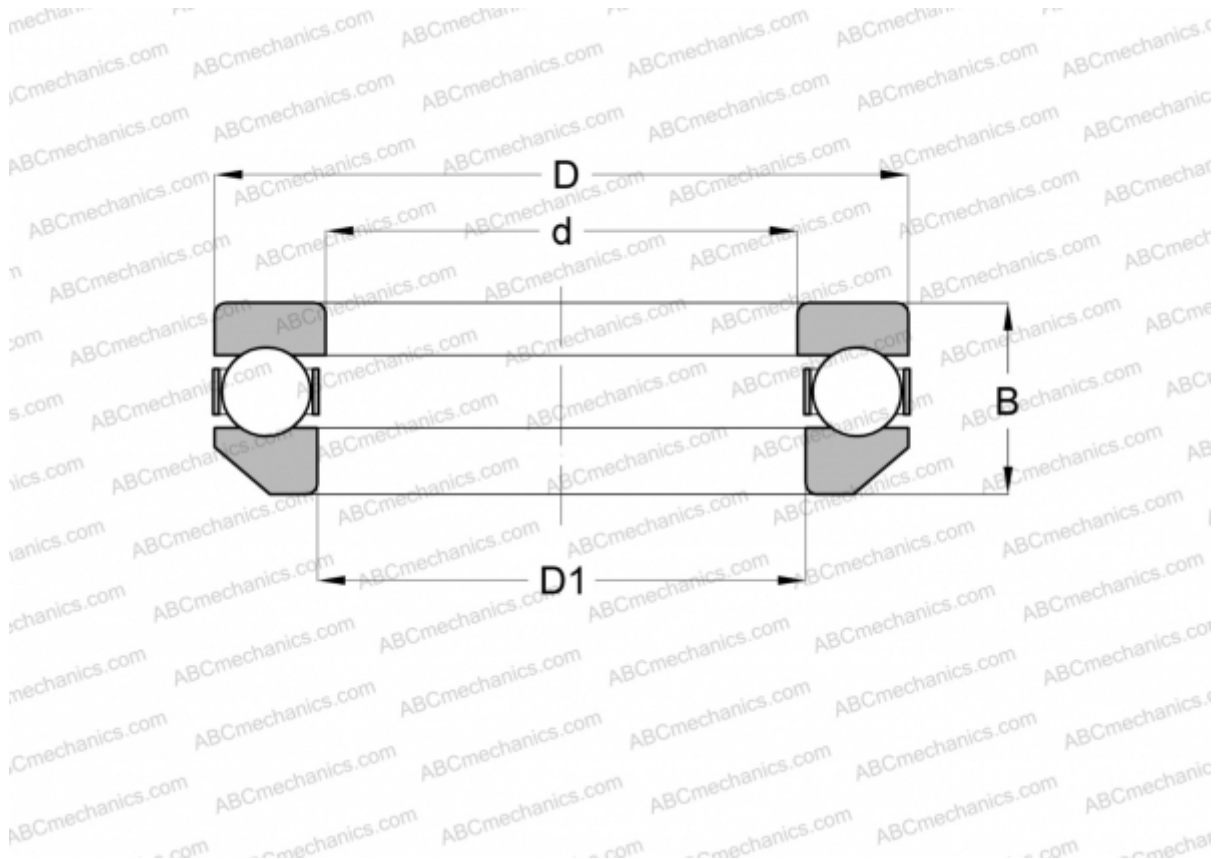

### Technical specification

#### DIMENSIONS, MM

d	17,000
D	37,000
D1	19,000
B	20,000

**WEIGHT, KG** 0,109

**MANUFACTURER** [INA](#)