

509 INA

Thrust ball bearings

TYPE: Ball bearings, Thrust ball bearing, Single direction, Separable, angular adjustment facility series 41/5

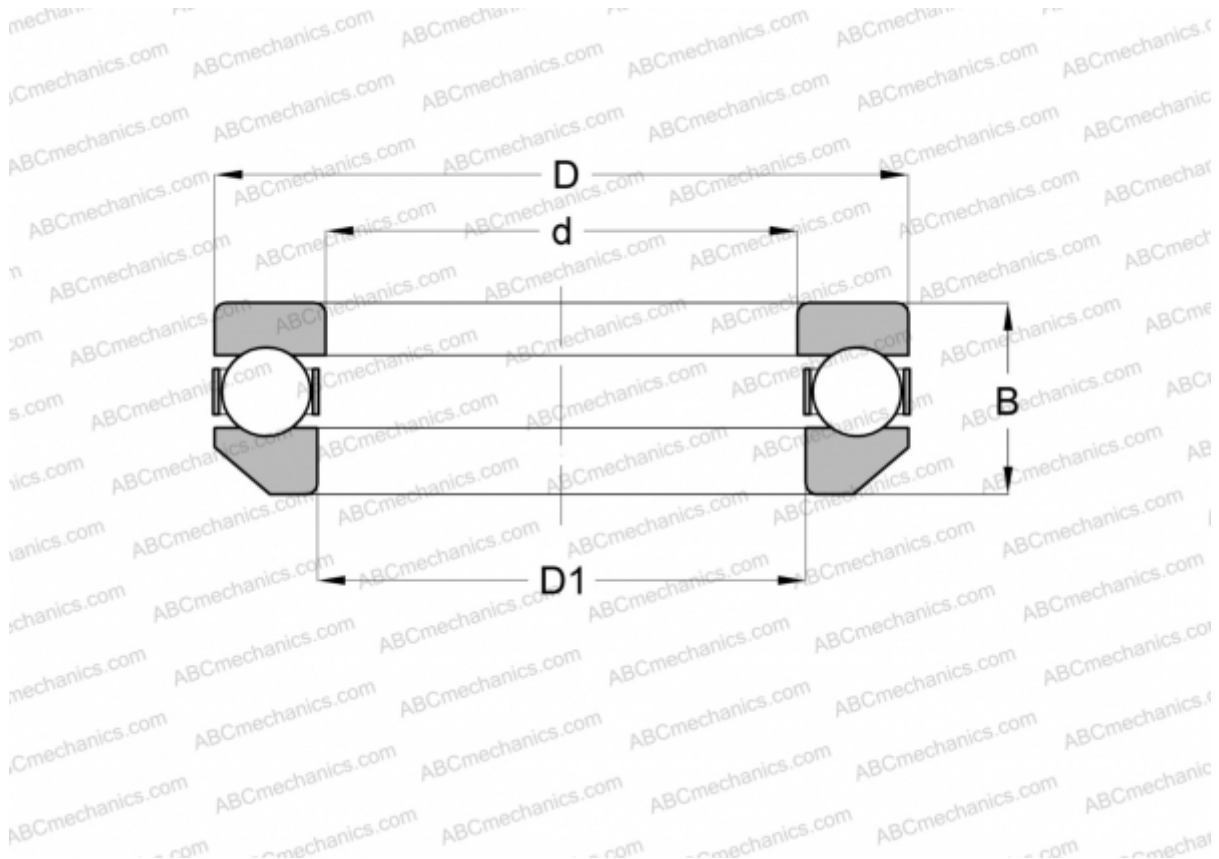

Technical specification

DIMENSIONS, MM

d	45,000
D	95,000
D1	1,727
B	50,000

WEIGHT, KG 47,000

MANUFACTURER [INA](#)