

D7 INA

Thrust ball bearings

TYPE: Ball bearings, Thrust ball bearing, Single direction, With bracket, inch size

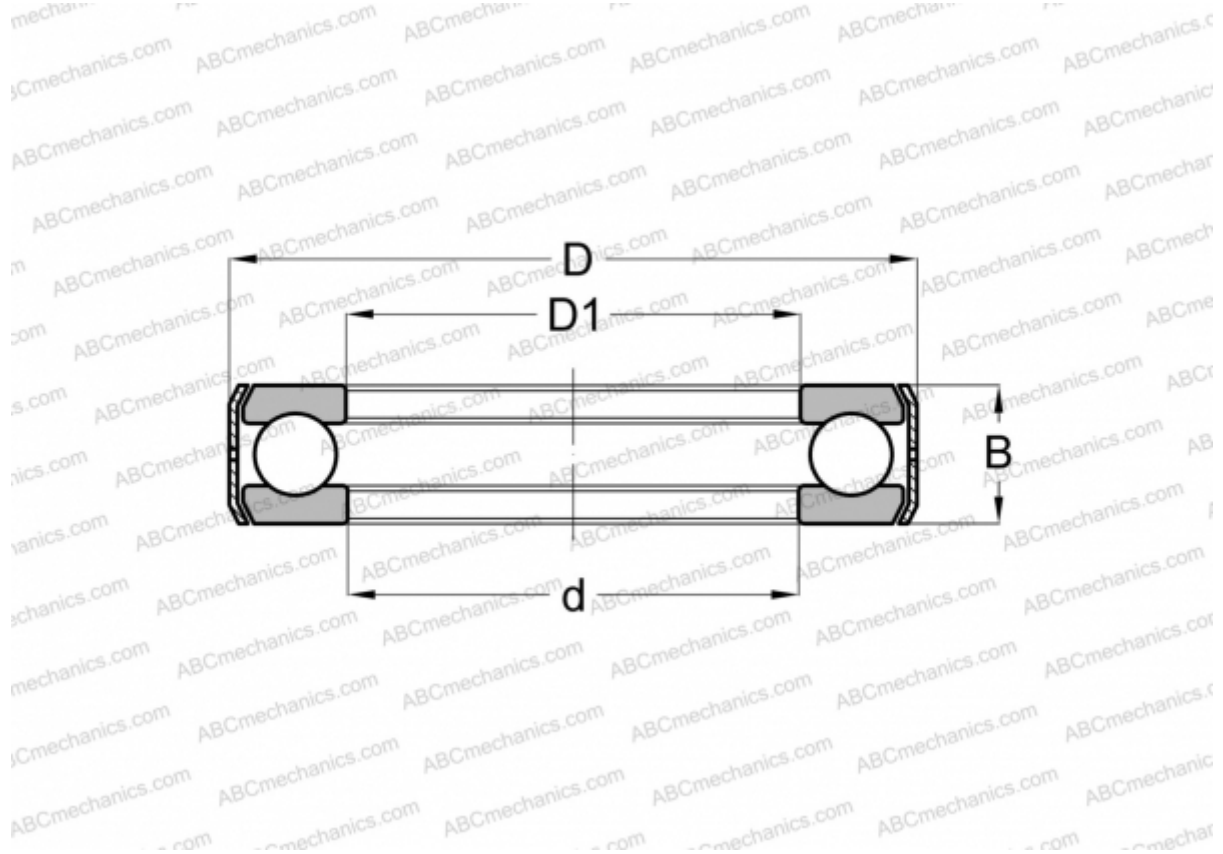

Technical specification

DIMENSIONS, MM

d	22,225
D	46,830
D1	23,018
B	15,875

WEIGHT, KG 0,126

MANUFACTURER [INA](#)

INTERCHANGE

AETNA	E-7
-------	---------------------