

D9 INA

Thrust ball bearings

TYPE: Ball bearings, Thrust ball bearing, Single direction, With bracket, inch size

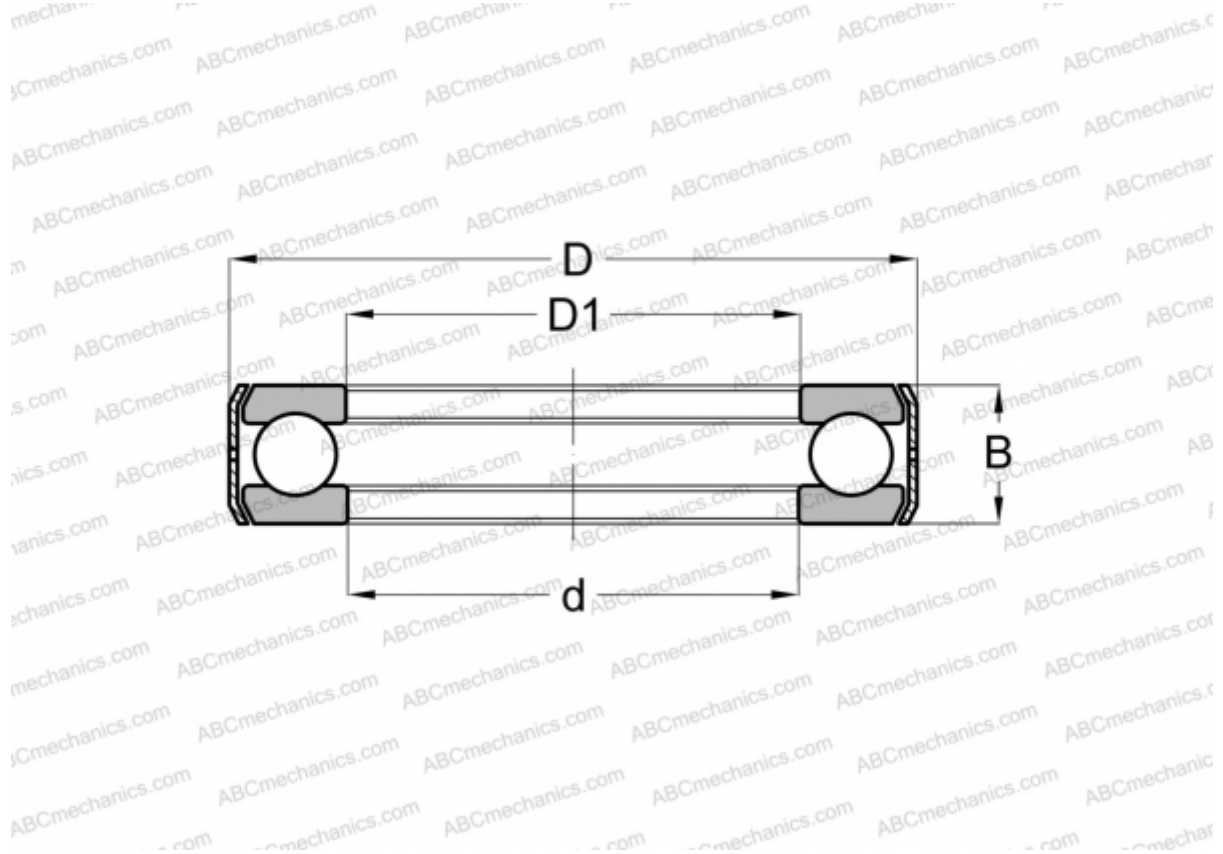

Technical specification

DIMENSIONS, MM

d	25,400
D	50,005
D1	26,193
B	15,875

WEIGHT, KG 0,137

MANUFACTURER [INA](#)

INTERCHANGE

AETNA	E-9
-------	---------------------