

E-10 AETNA

Thrust ball bearings

TYPE: Ball bearings, Thrust ball bearing, Single direction, With bracket, inch size

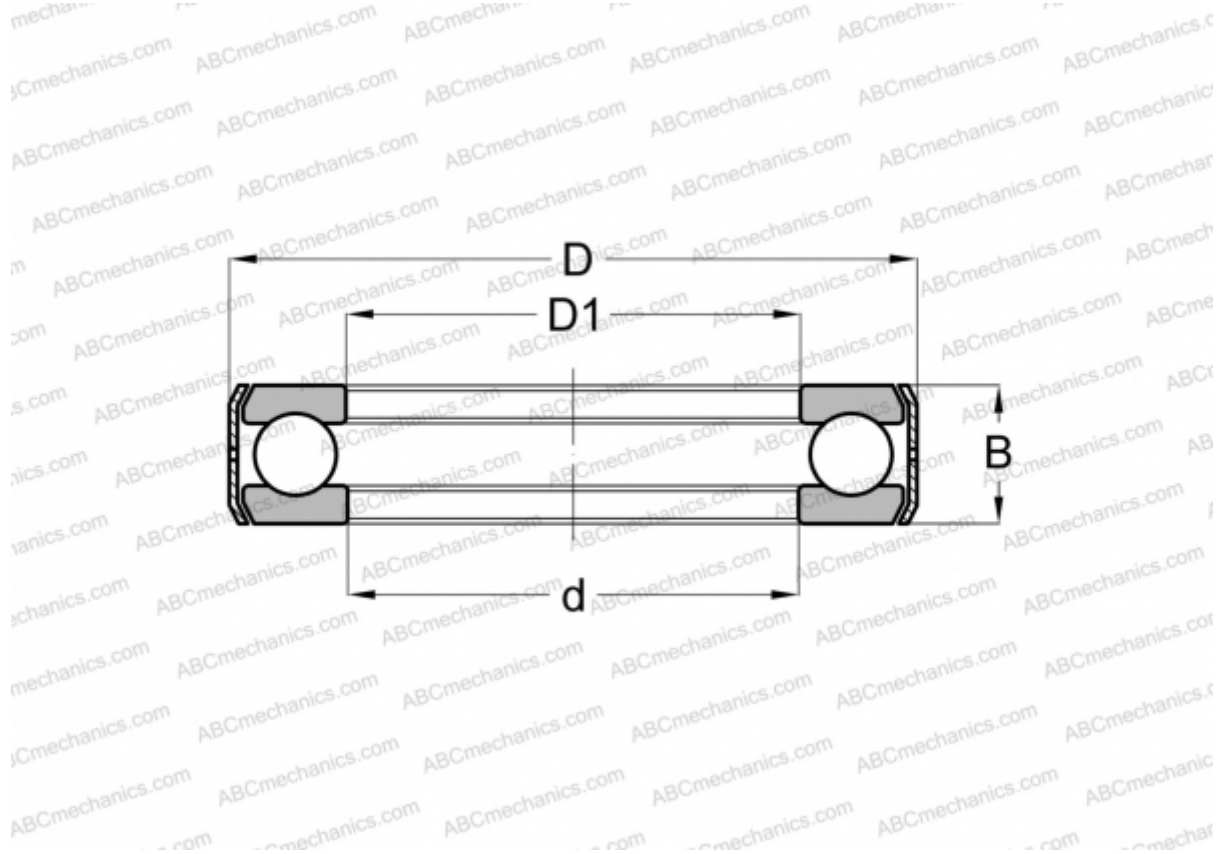

Technical specification

DIMENSIONS, MM

d	26,988
D	50,005
D1	27,780
B	15,875

WEIGHT, KG 0,130

MANUFACTURER [AETNA](#)

INTERCHANGE

INA	D10
-----	---------------------