

## D14 INA

Thrust ball bearings

TYPE: Ball bearings, Thrust ball bearing, Single direction, With bracket, inch size

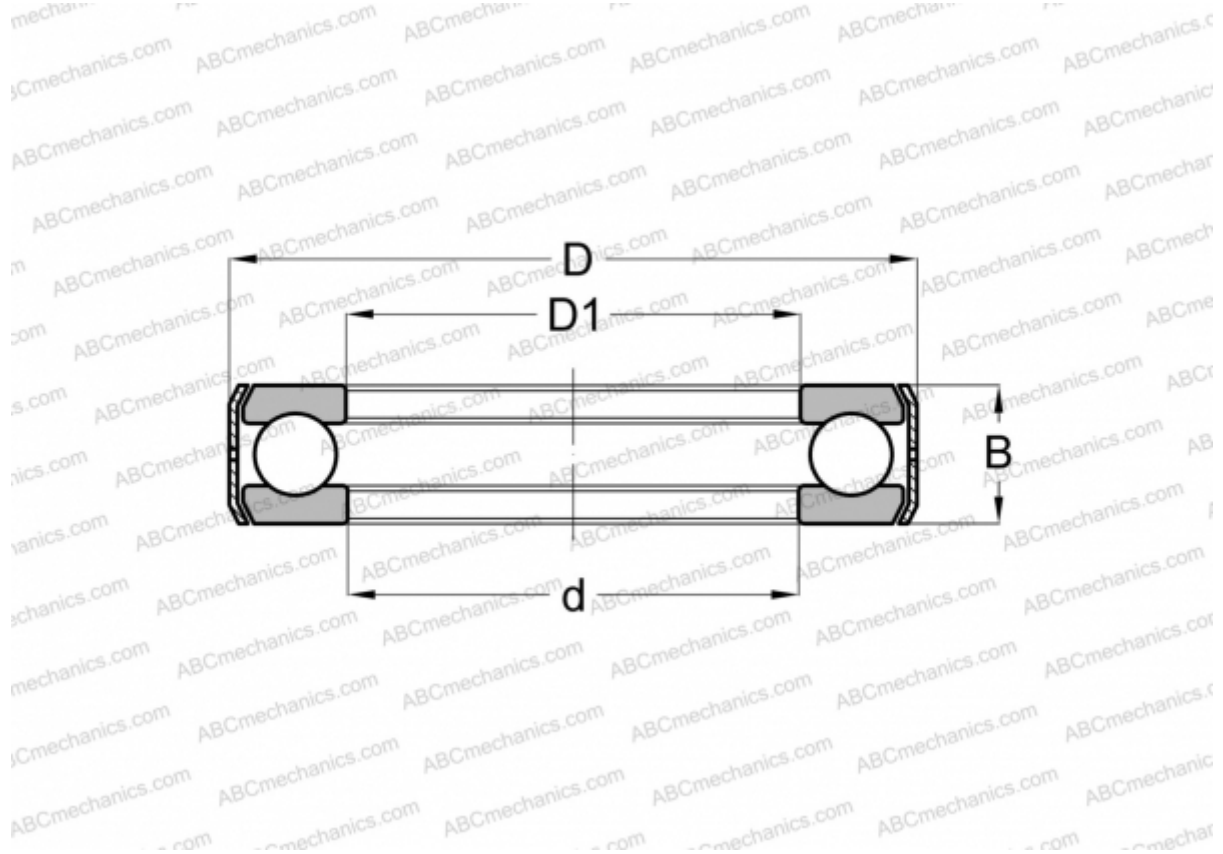

### Technical specification

#### DIMENSIONS, MM

d	33,338
D	59,530
D1	34,130
B	15,875

**WEIGHT, KG** 0,180

**MANUFACTURER** [INA](#)

#### INTERCHANGE

AETNA [E-14](#)