

E-17 AETNA

Thrust ball bearings

TYPE: Ball bearings, Thrust ball bearing, Single direction, With bracket, inch size

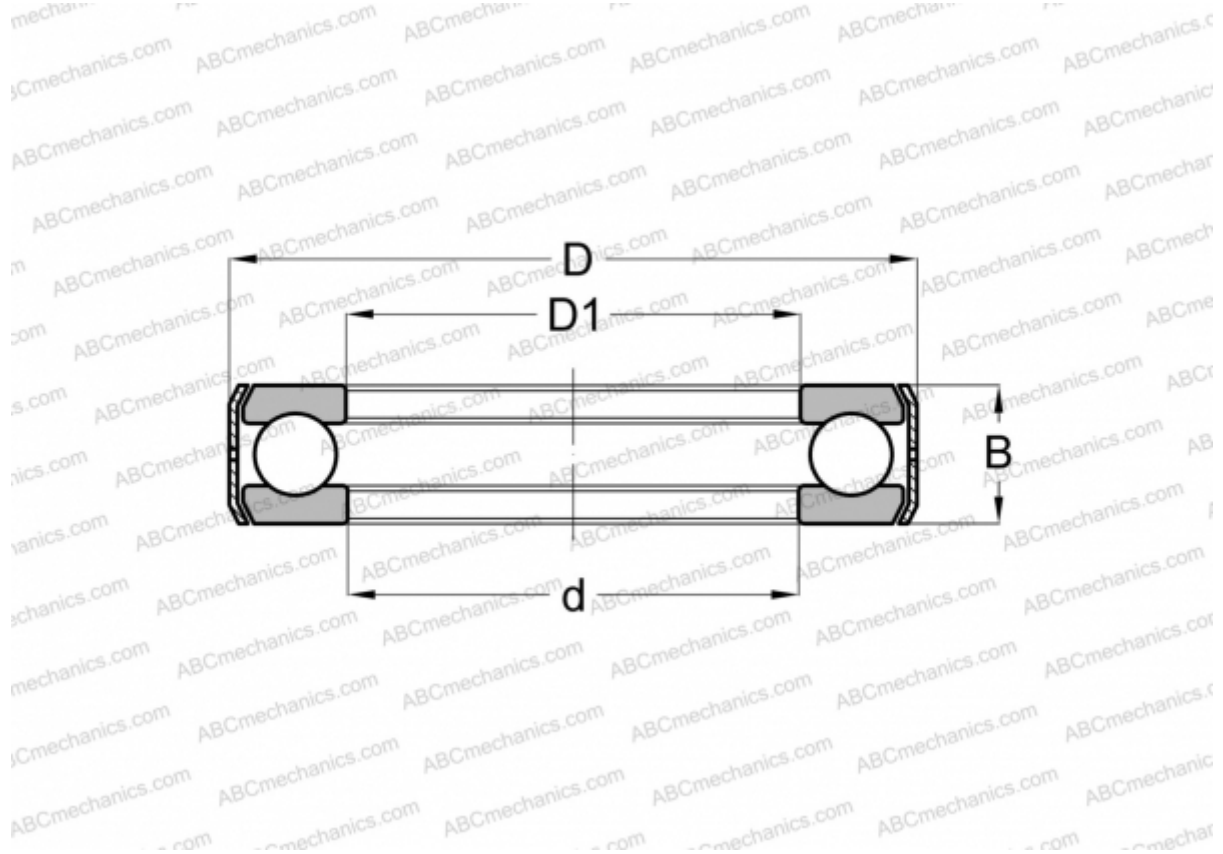

Technical specification

DIMENSIONS, MM

d	38,100
D	65,880
D1	38,633
B	15,875

WEIGHT, KG 0,209

MANUFACTURER [AETNA](#)

INTERCHANGE

INA	D17
-----	---------------------