

E-20 AETNA

Thrust ball bearings

TYPE: Ball bearings, Thrust ball bearing, Single direction, With bracket, inch size

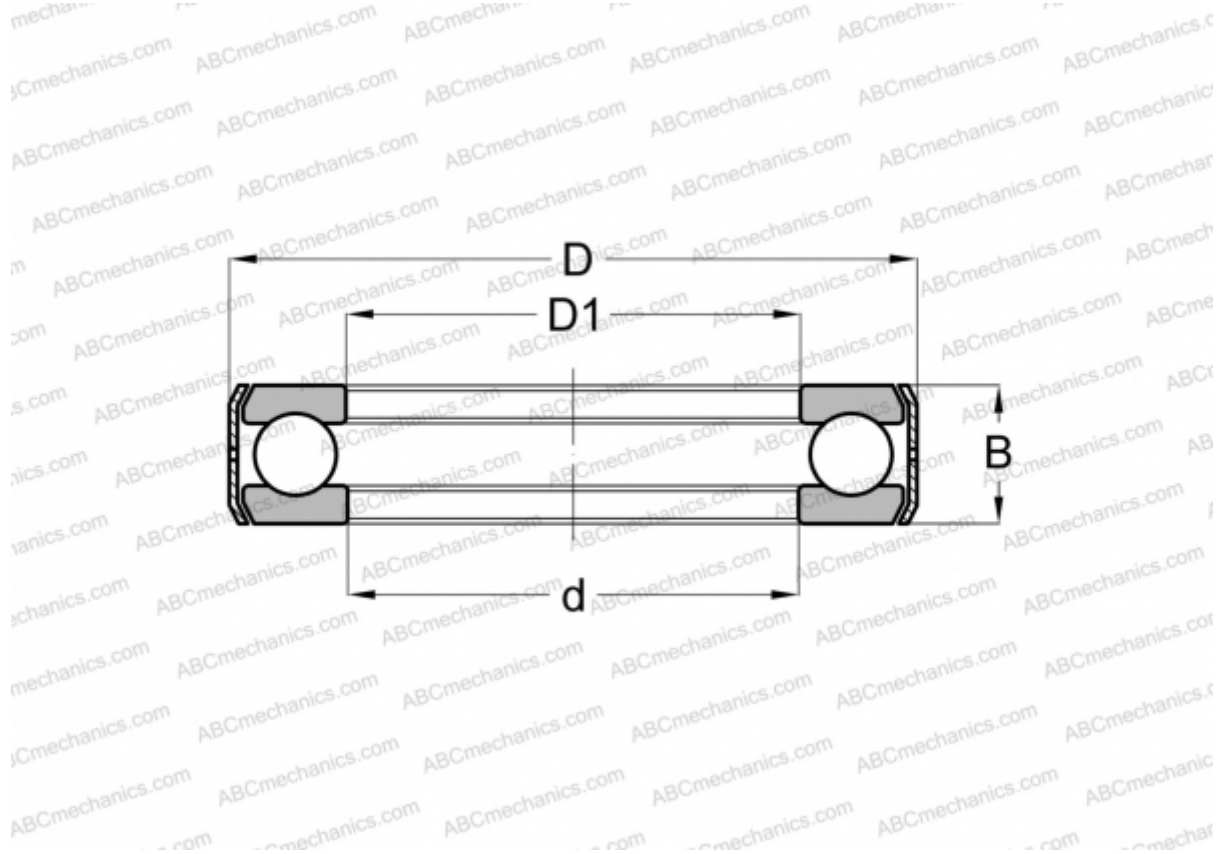

Technical specification

DIMENSIONS, MM

d	42,863
D	75,405
D1	43,655
B	20,638

WEIGHT, KG 0,380

MANUFACTURER [AETNA](#)

INTERCHANGE

INA	D20
-----	---------------------