

D22 INA

Thrust ball bearings

TYPE: Ball bearings, Thrust ball bearing, Single direction, With bracket, inch size

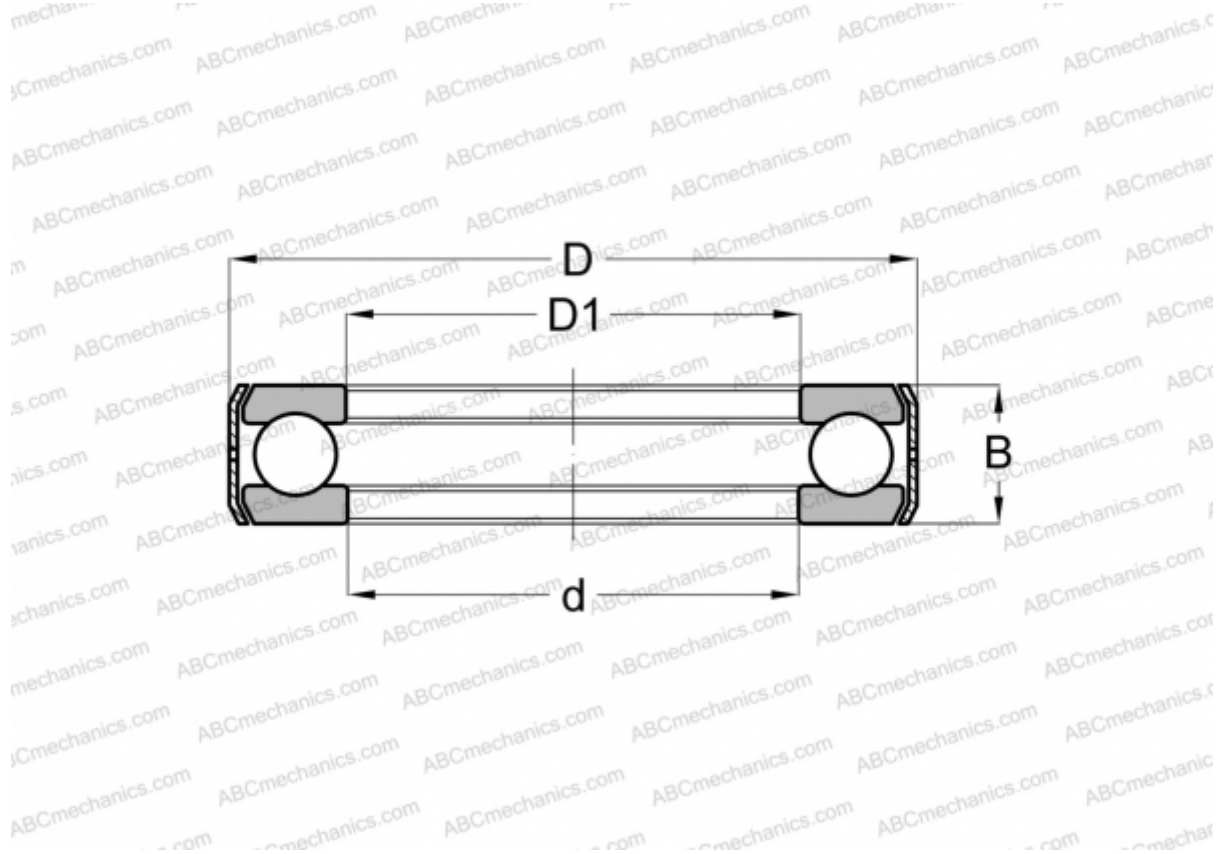

Technical specification

DIMENSIONS, MM

d	46,038
D	78,580
D1	46,830
B	20,638

WEIGHT, KG 0,391

MANUFACTURER [INA](#)

INTERCHANGE

AETNA	E-22
-------	----------------------