

D31 INA

Thrust ball bearings

TYPE: Ball bearings, Thrust ball bearing, Single direction, With bracket, inch size

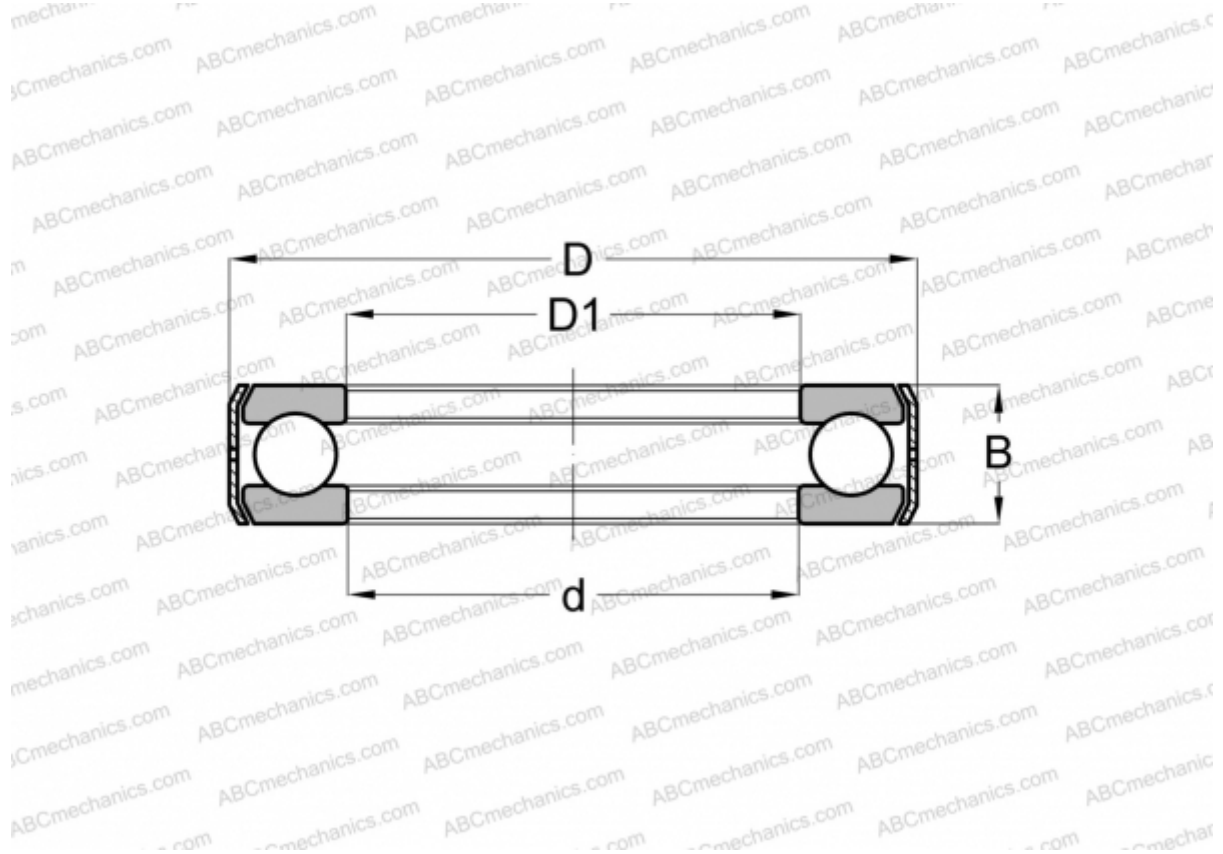

Technical specification

DIMENSIONS, MM

d	60,325
D	97,630
D1	61,118
B	20,638

WEIGHT, KG 0,567

MANUFACTURER [INA](#)

INTERCHANGE

AETNA [E-31](#)