

D37 INA

Thrust ball bearings

TYPE: Ball bearings, Thrust ball bearing, Single direction, With bracket, inch size

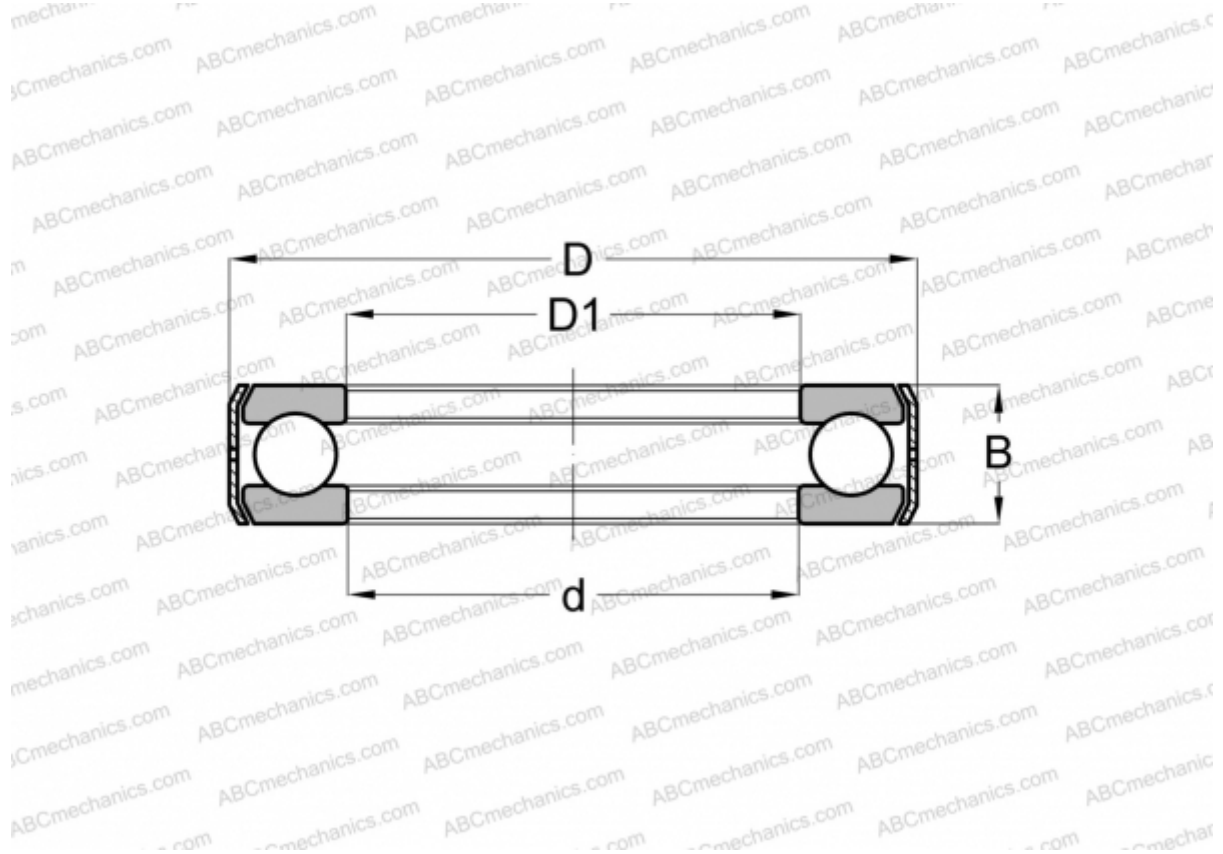

Technical specification

DIMENSIONS, MM

d	69,850
D	113,505
D1	70,643
B	25,400

WEIGHT, KG 0,953

MANUFACTURER [INA](#)

INTERCHANGE

AETNA	E-37
-------	----------------------