

B3 INA

Thrust ball bearings

TYPE: Ball bearings, Thrust ball bearing, Single direction, With bracket, inch size

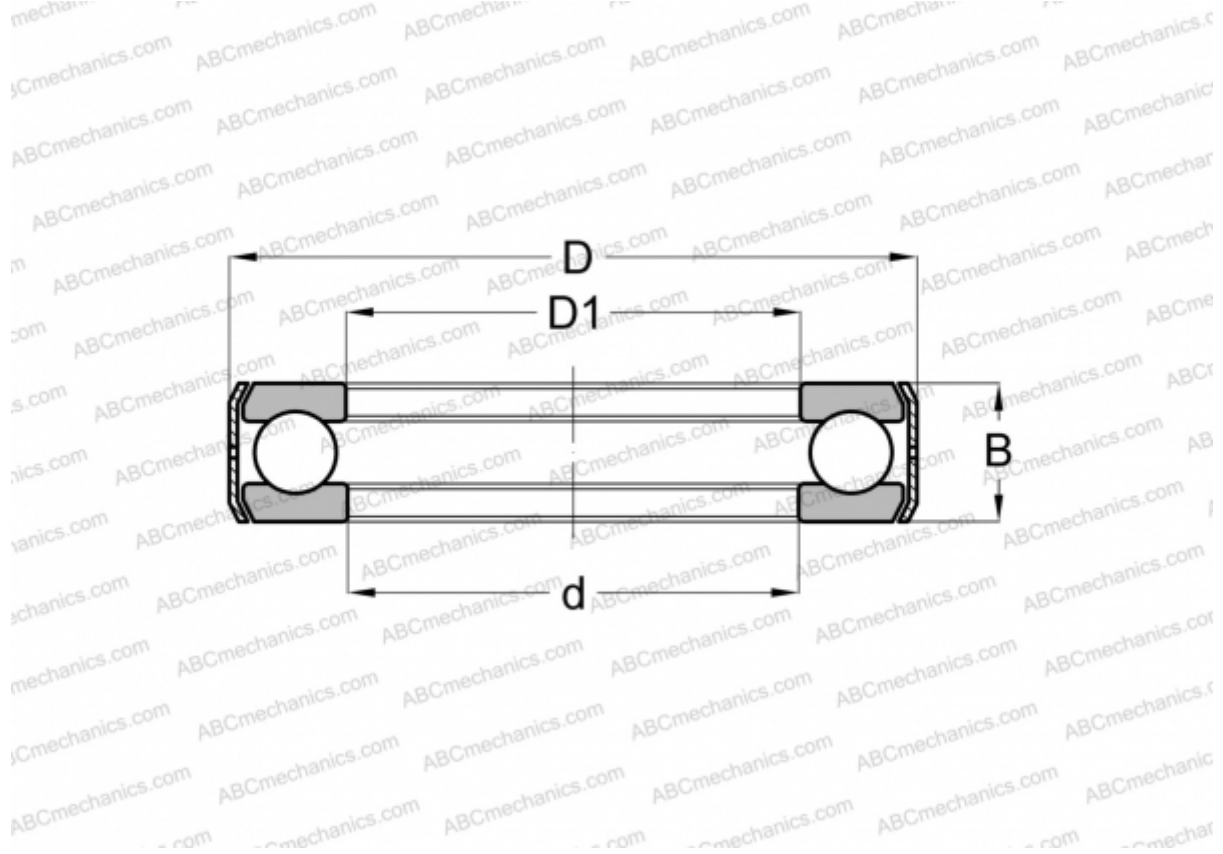

Technical specification

DIMENSIONS, MM

d	15,875
D	34,138
D1	16,662
B	15,875

WEIGHT, KG 0,070

MANUFACTURER [INA](#)