

B10 INA

Thrust ball bearings

TYPE: Ball bearings, Thrust ball bearing, Single direction, With bracket, inch size

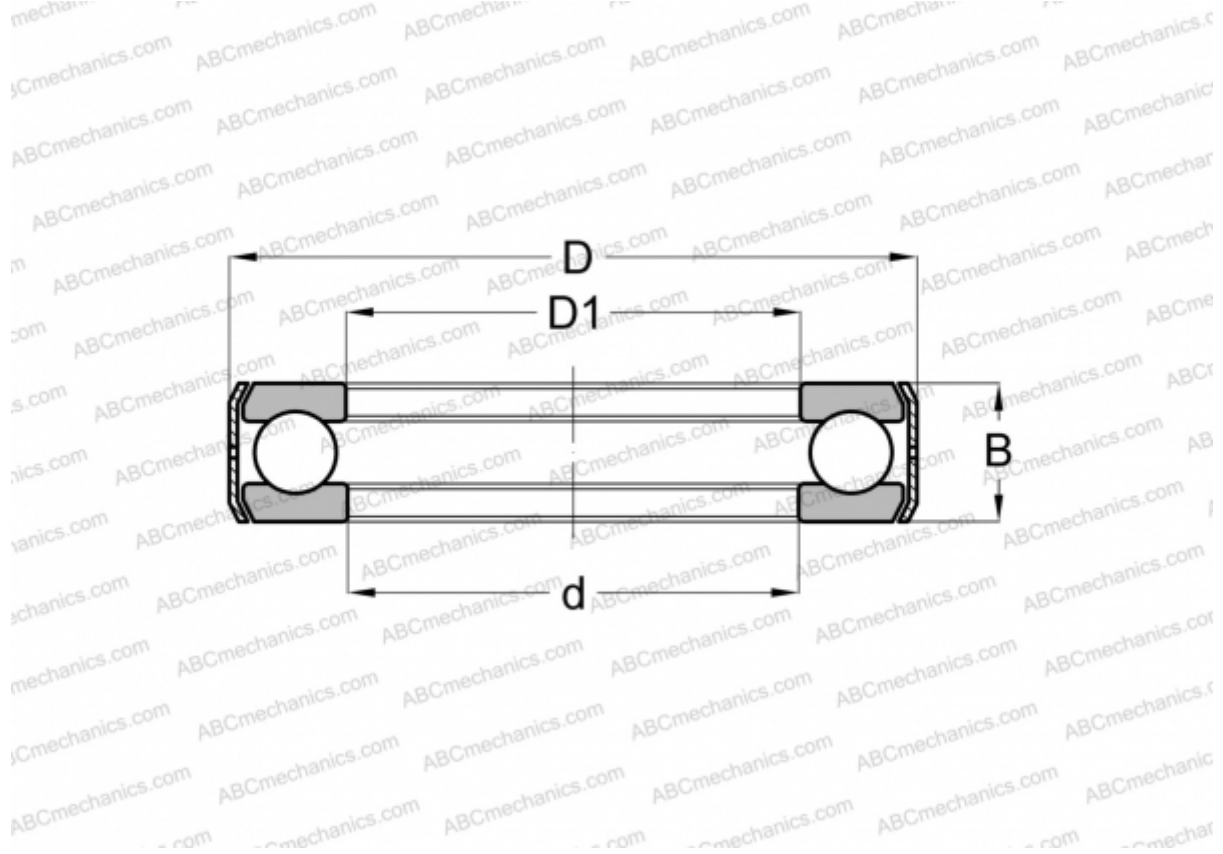

Technical specification

DIMENSIONS, MM

d	26,988
D	50,012
D1	27,788
B	19,050

WEIGHT, KG 0,162

MANUFACTURER [INA](#)