

B15 INA

Thrust ball bearings

TYPE: Ball bearings, Thrust ball bearing, Single direction, With bracket, inch size

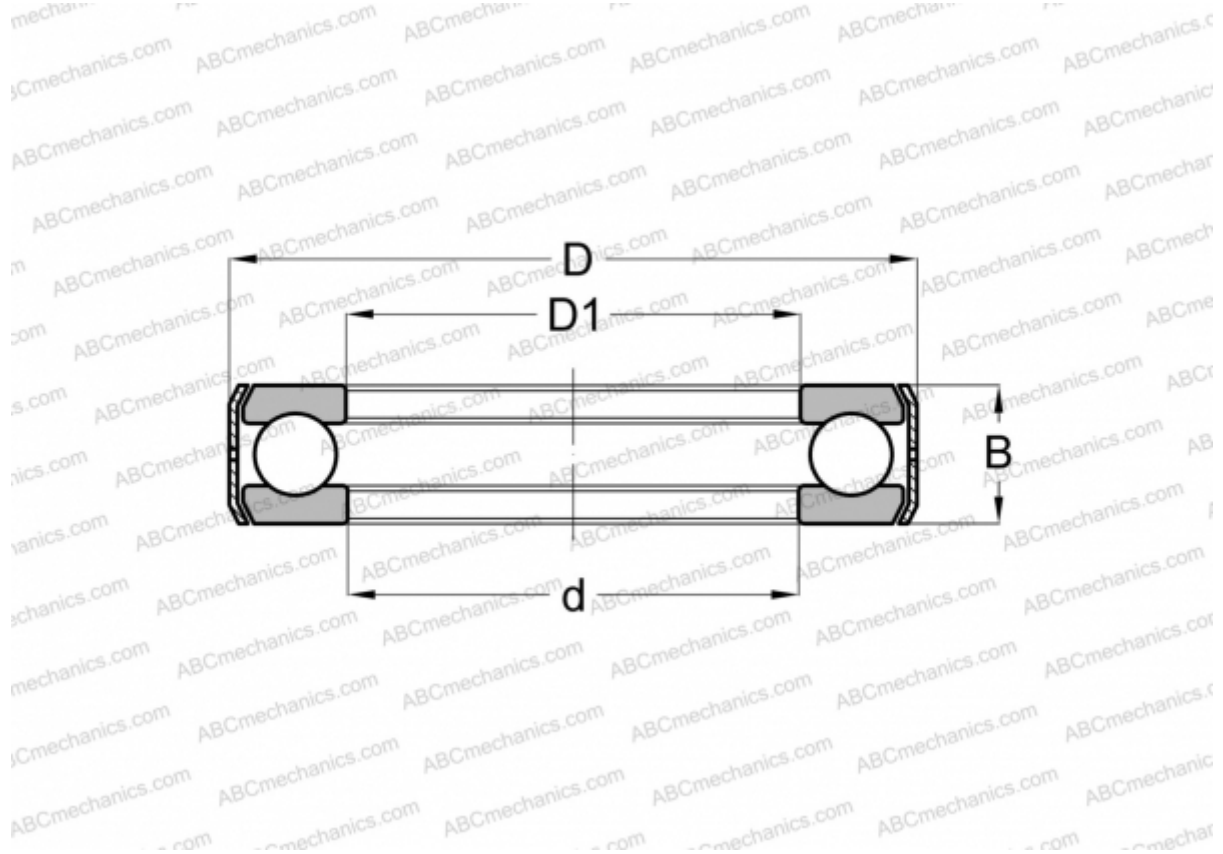

Technical specification

DIMENSIONS, MM

d	34,925
D	62,713
D1	35,712
B	19,050

WEIGHT, KG 0,239

MANUFACTURER [INA](#)