

B16 INA

Thrust ball bearings

TYPE: Ball bearings, Thrust ball bearing, Single direction, With bracket, inch size

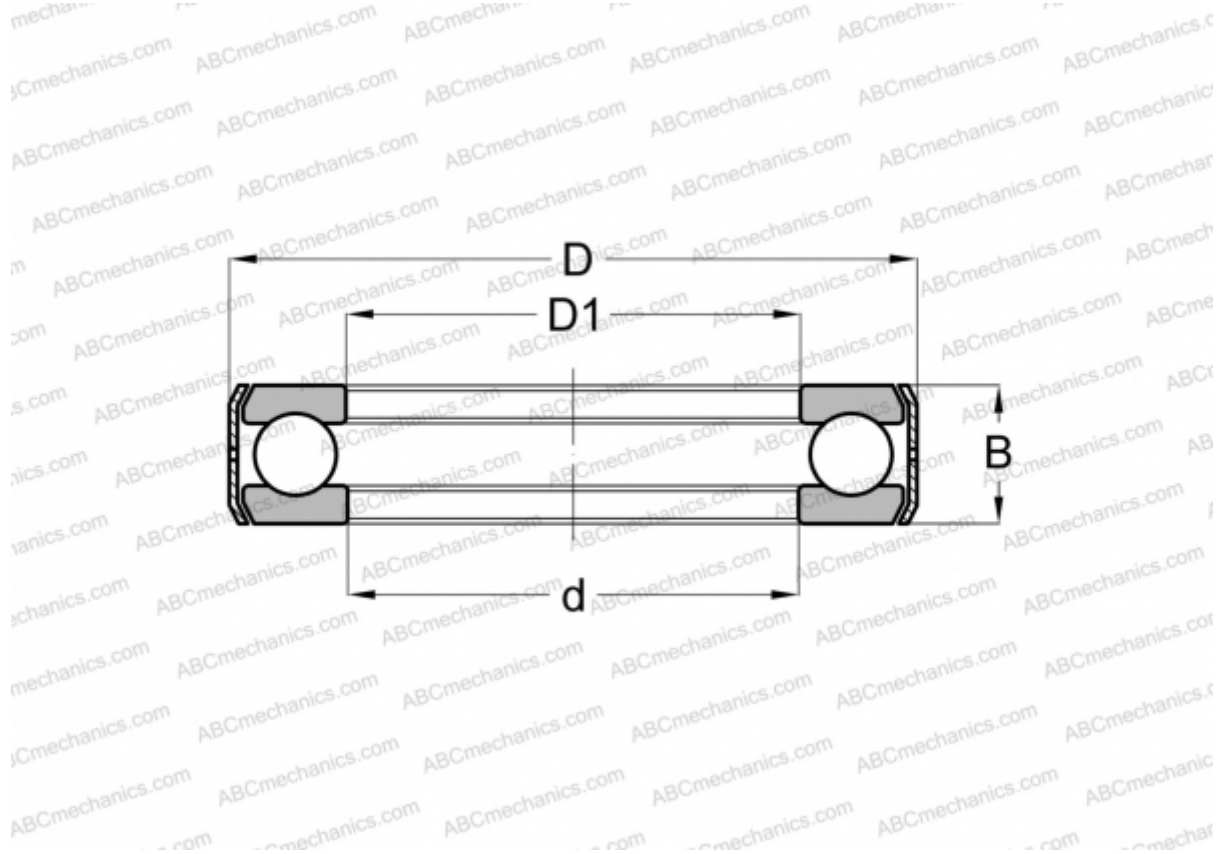

Technical specification

DIMENSIONS, MM

d	36,513
D	62,710
D1	37,313
B	19,050

WEIGHT, KG 0,232

MANUFACTURER [INA](#)