

B19 INA

Thrust ball bearings

TYPE: Ball bearings, Thrust ball bearing, Single direction, With bracket, inch size

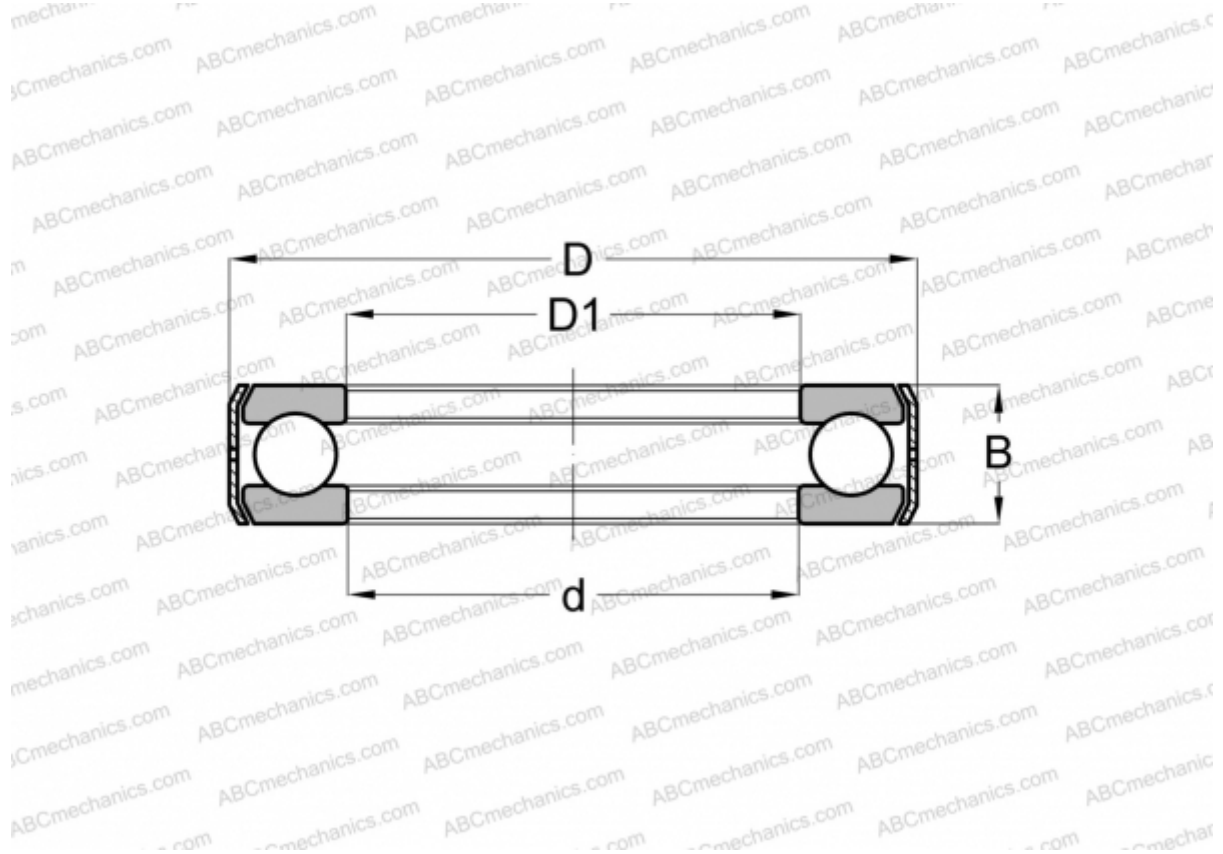

Technical specification

DIMENSIONS, MM

d	41,275
D	75,410
D1	42,062
B	22,220

WEIGHT, KG 0,394

MANUFACTURER [INA](#)