

B21 INA

Thrust ball bearings

TYPE: Ball bearings, Thrust ball bearing, Single direction, With bracket, inch size

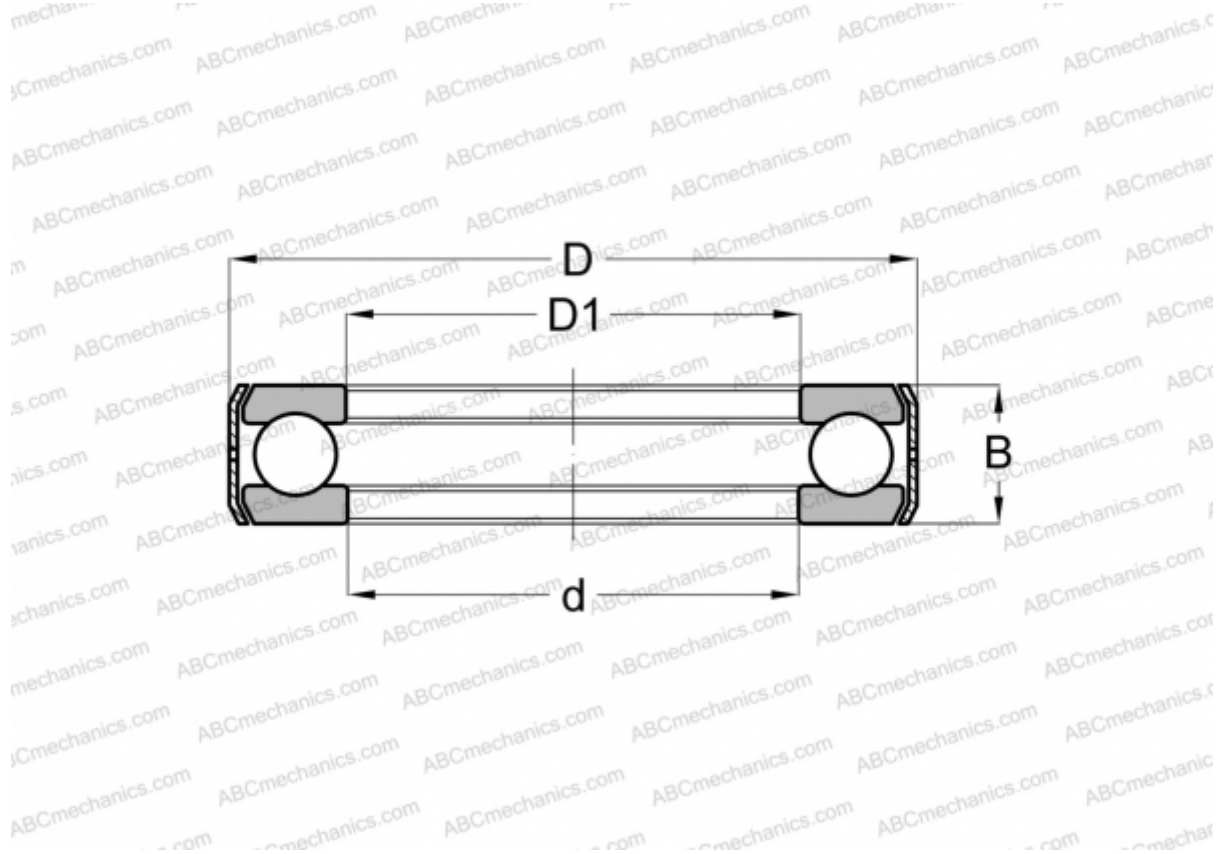

Technical specification

DIMENSIONS, MM

d	44,450
D	78,590
D1	45,237
B	22,220

WEIGHT, KG 0,418

MANUFACTURER [INA](#)