

B24 INA

Thrust ball bearings

TYPE: Ball bearings, Thrust ball bearing, Single direction, With bracket, inch size

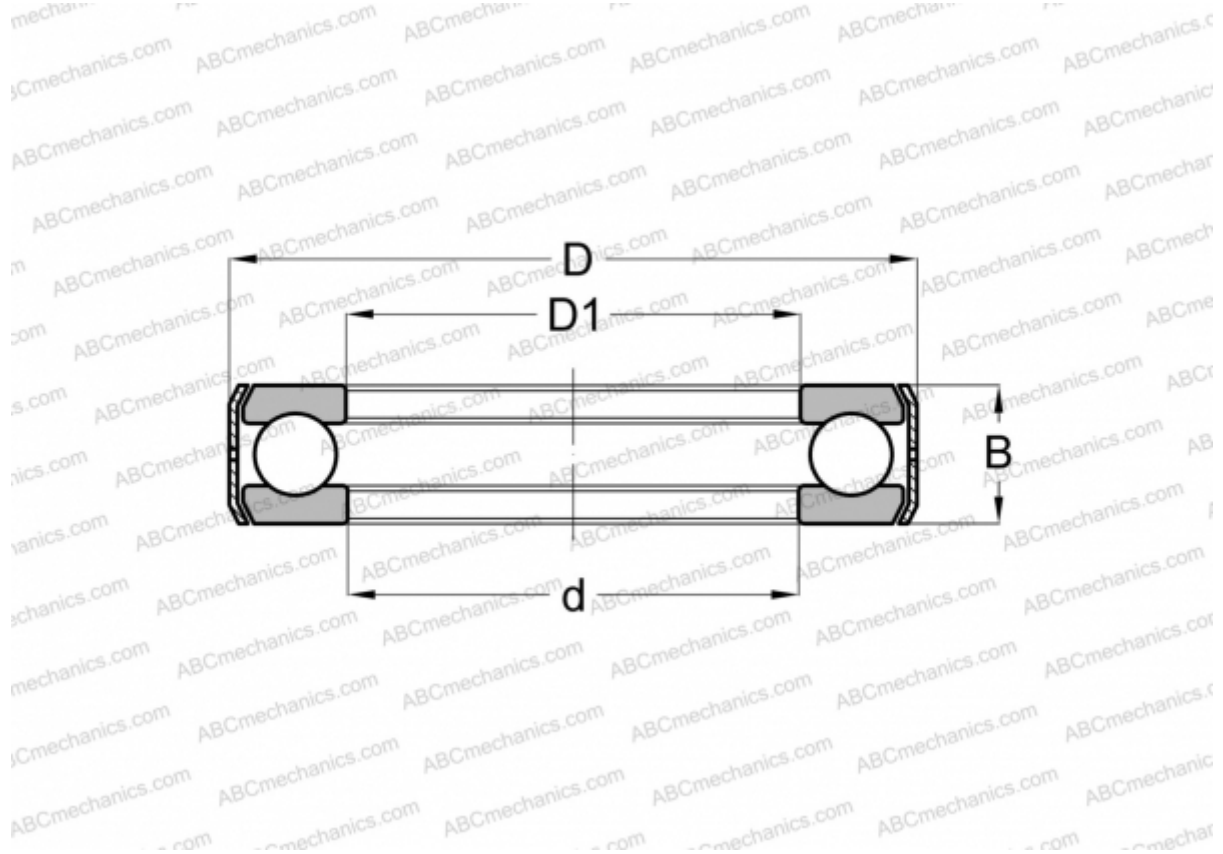

Technical specification

DIMENSIONS, MM

d	49,213
D	81,760
D1	50,013
B	22,220

WEIGHT, KG 0,427

MANUFACTURER [INA](#)