

B25 INA

Thrust ball bearings

TYPE: Ball bearings, Thrust ball bearing, Single direction, With bracket, inch size

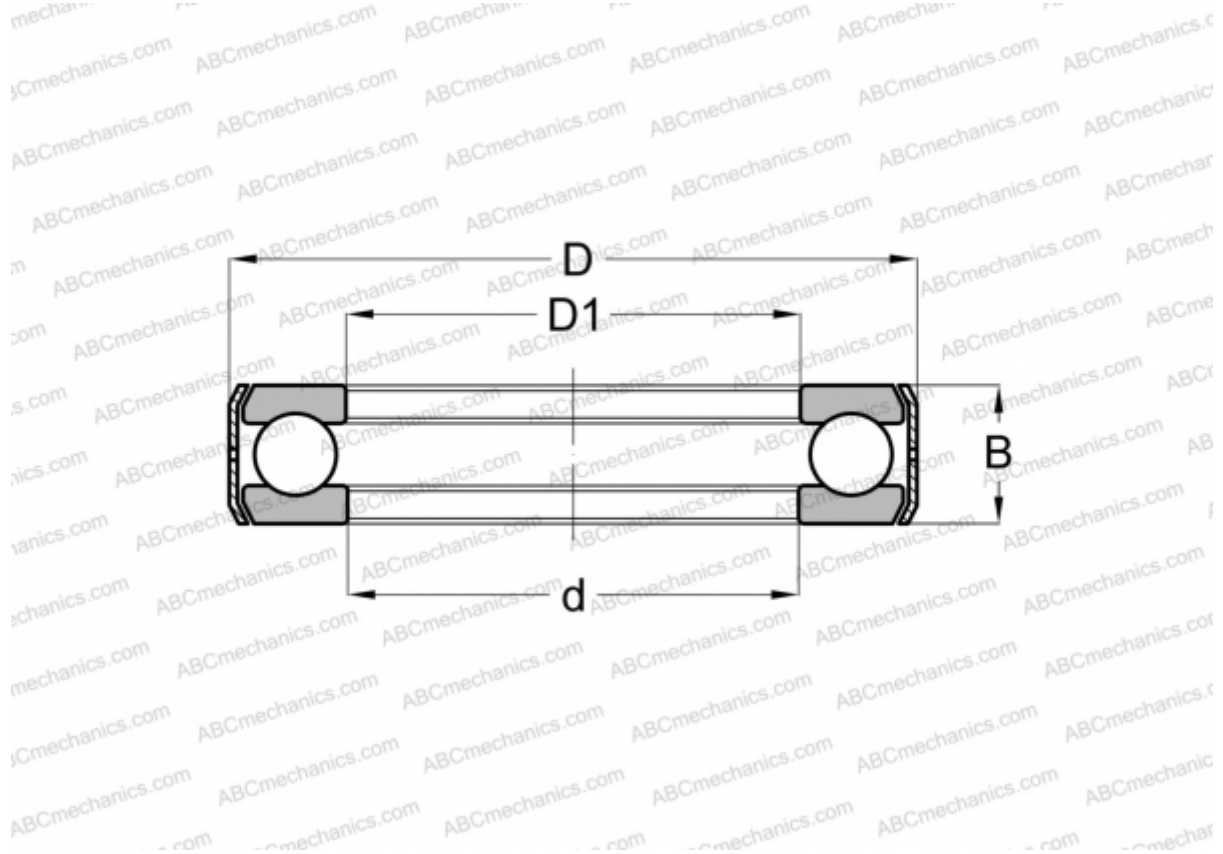

Technical specification

DIMENSIONS, MM

d	50,800
D	84,940
D1	51,587
B	22,220

WEIGHT, KG 0,461

MANUFACTURER [INA](#)