

B-1 AETNA

Thrust ball bearings

TYPE: Ball bearings, Thrust ball bearing, Single direction, Separable, flat raceway, inch size

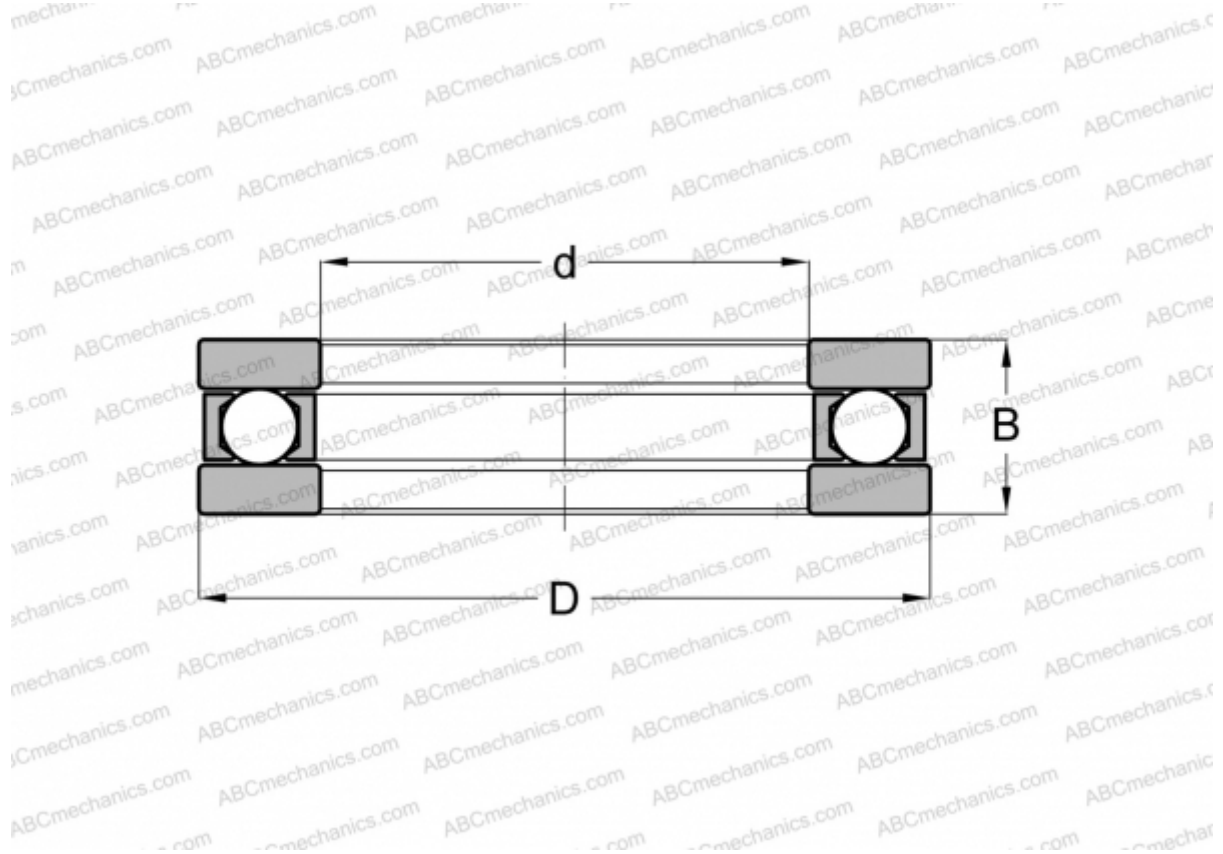

Technical specification

DIMENSIONS, MM

d	12,700
D	30,955
B	14,288

WEIGHT, KG 0,060

MANUFACTURER [AETNA](#)

INTERCHANGE

INA	FT-1
ANDREWS	FT-1