

## B-4 AETNA

Thrust ball bearings

TYPE: Ball bearings, Thrust ball bearing, Single direction, Separable, flat raceway, inch size

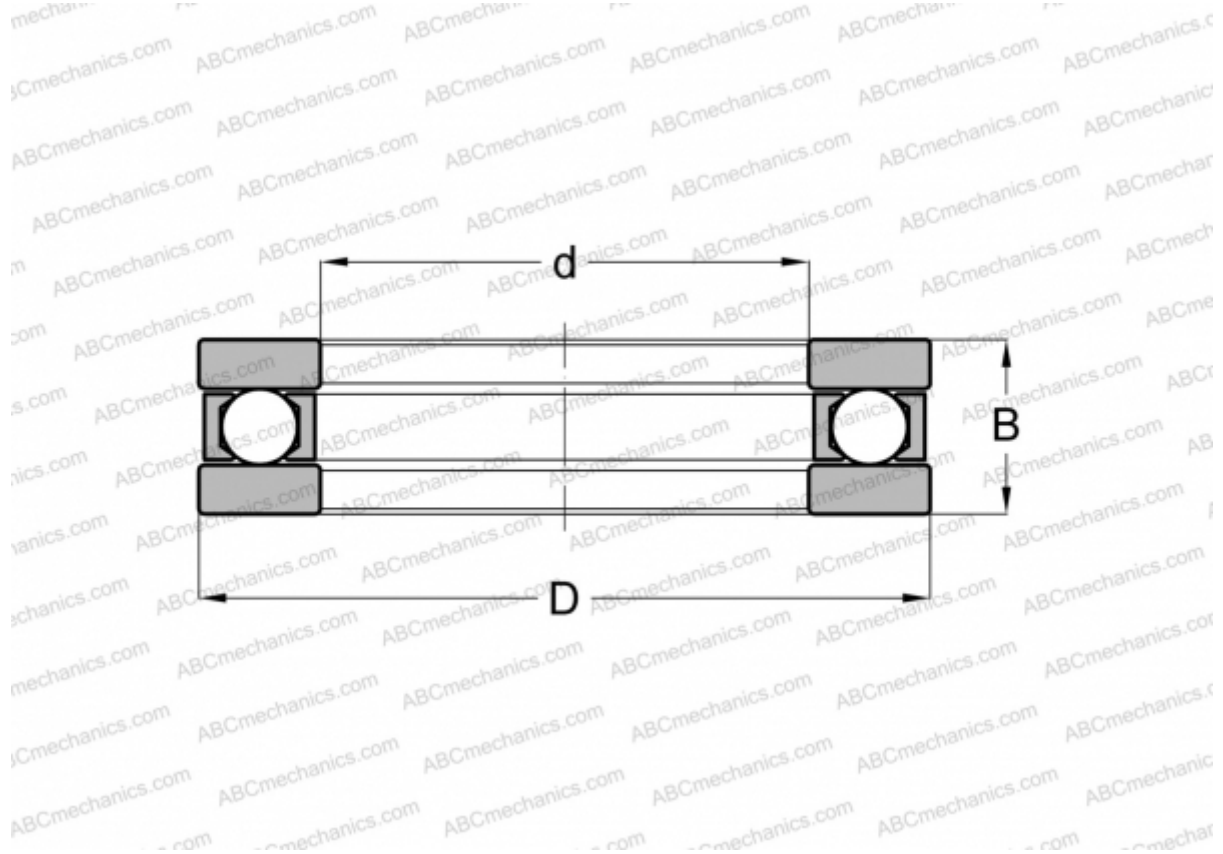

### Technical specification

#### DIMENSIONS, MM

d	17,463
D	34,130
B	14,288

**WEIGHT, KG** 0,065

**MANUFACTURER** [AETNA](#)

#### INTERCHANGE

INA	<a href="#">FT-4</a>
ANDREWS	<a href="#">FT-4</a>