

B-6 AETNA

Thrust ball bearings

TYPE: Ball bearings, Thrust ball bearing, Single direction, Separable, flat raceway, inch size

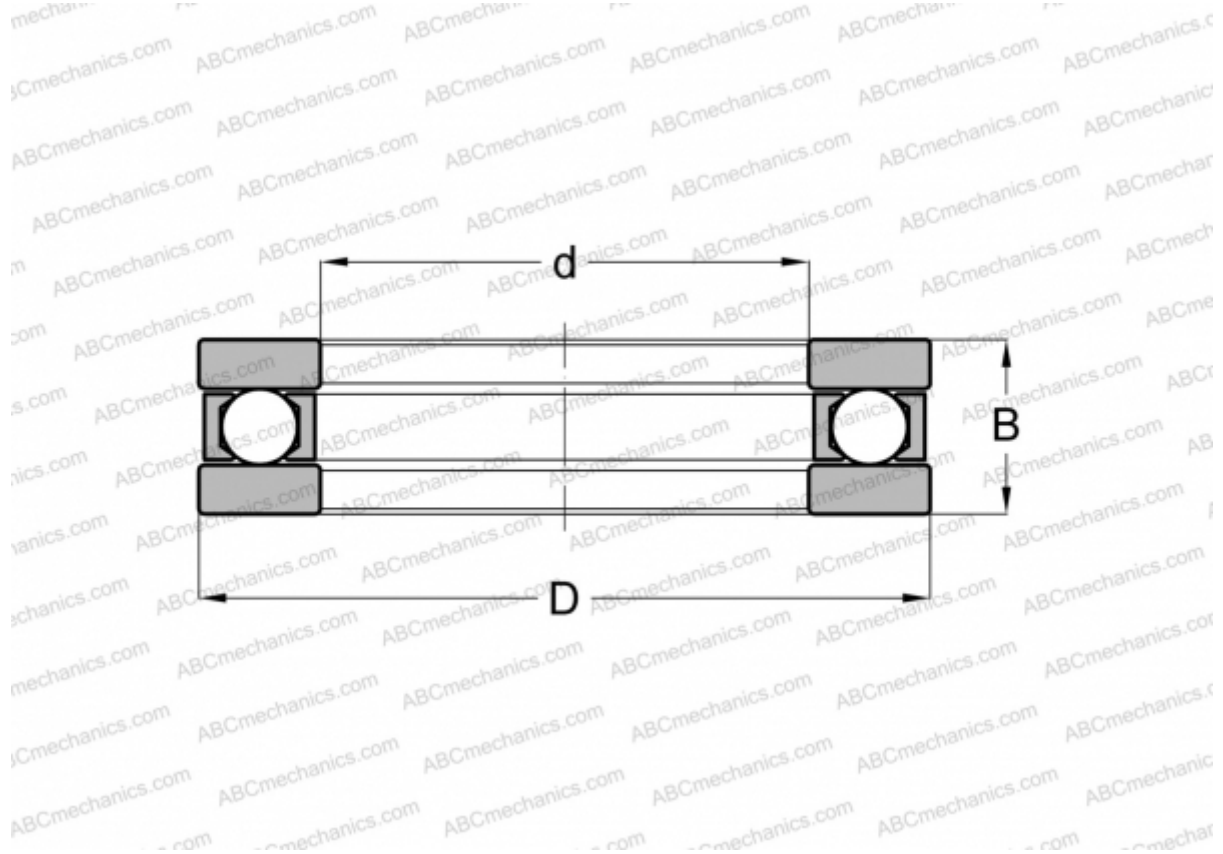

Technical specification

DIMENSIONS, MM

d	20,638
D	37,305
B	14,288

WEIGHT, KG 0,070

MANUFACTURER [AETNA](#)

INTERCHANGE

INA	FT-6
ANDREWS	FT-6