

B-8 AETNA

Thrust ball bearings

TYPE: Ball bearings, Thrust ball bearing, Single direction, Separable, flat raceway, inch size

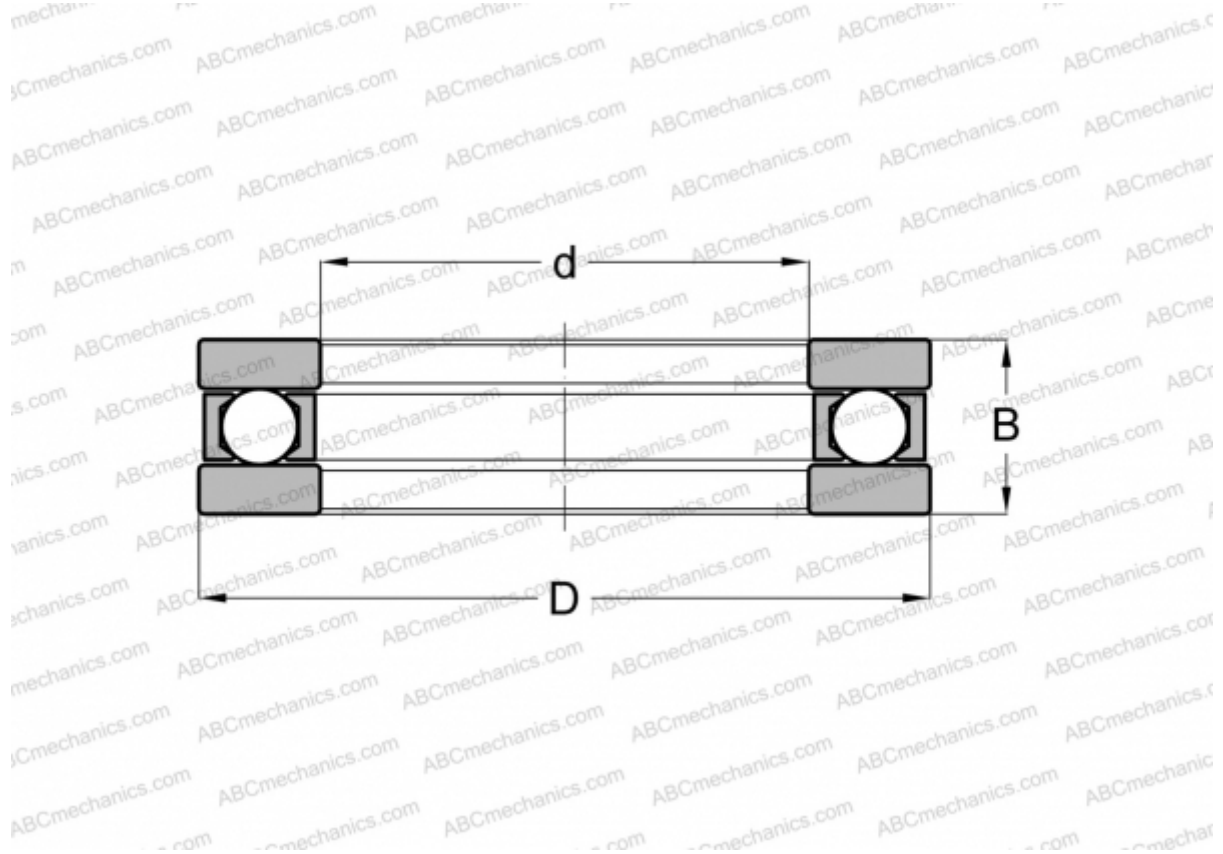

Technical specification

DIMENSIONS, MM

d	23,813
D	46,830
B	15,875

WEIGHT, KG 0,133

MANUFACTURER [AETNA](#)

INTERCHANGE

INA	FT-8
ANDREWS	FT-8