

B-9 AETNA

Thrust ball bearings

TYPE: Ball bearings, Thrust ball bearing, Single direction, Separable, flat raceway, inch size

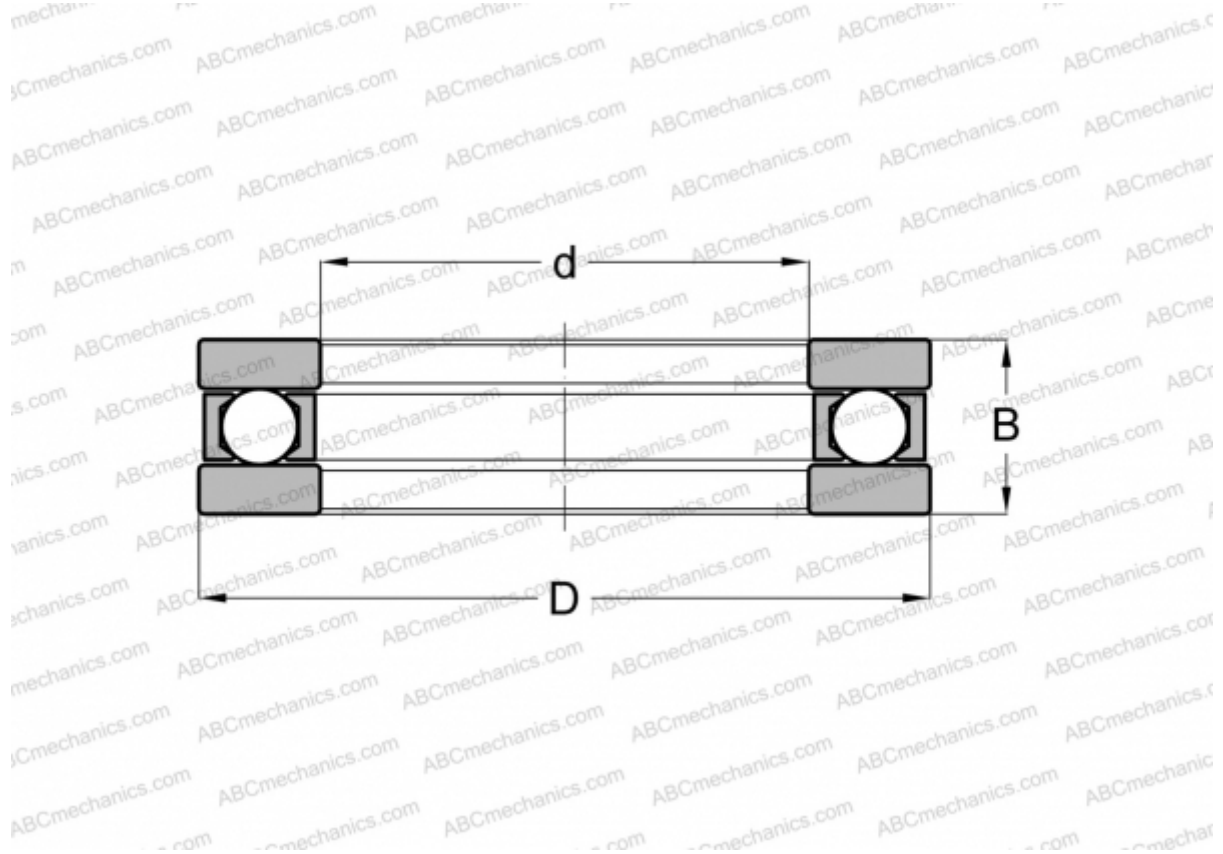

Technical specification

DIMENSIONS, MM

d	25,400
D	50,005
B	15,875

WEIGHT, KG 0,147

MANUFACTURER [AETNA](#)

INTERCHANGE

INA	FT-9
ANDREWS	FT-9