

B-14 AETNA

Thrust ball bearings

TYPE: Ball bearings, Thrust ball bearing, Single direction, Separable, flat raceway, inch size

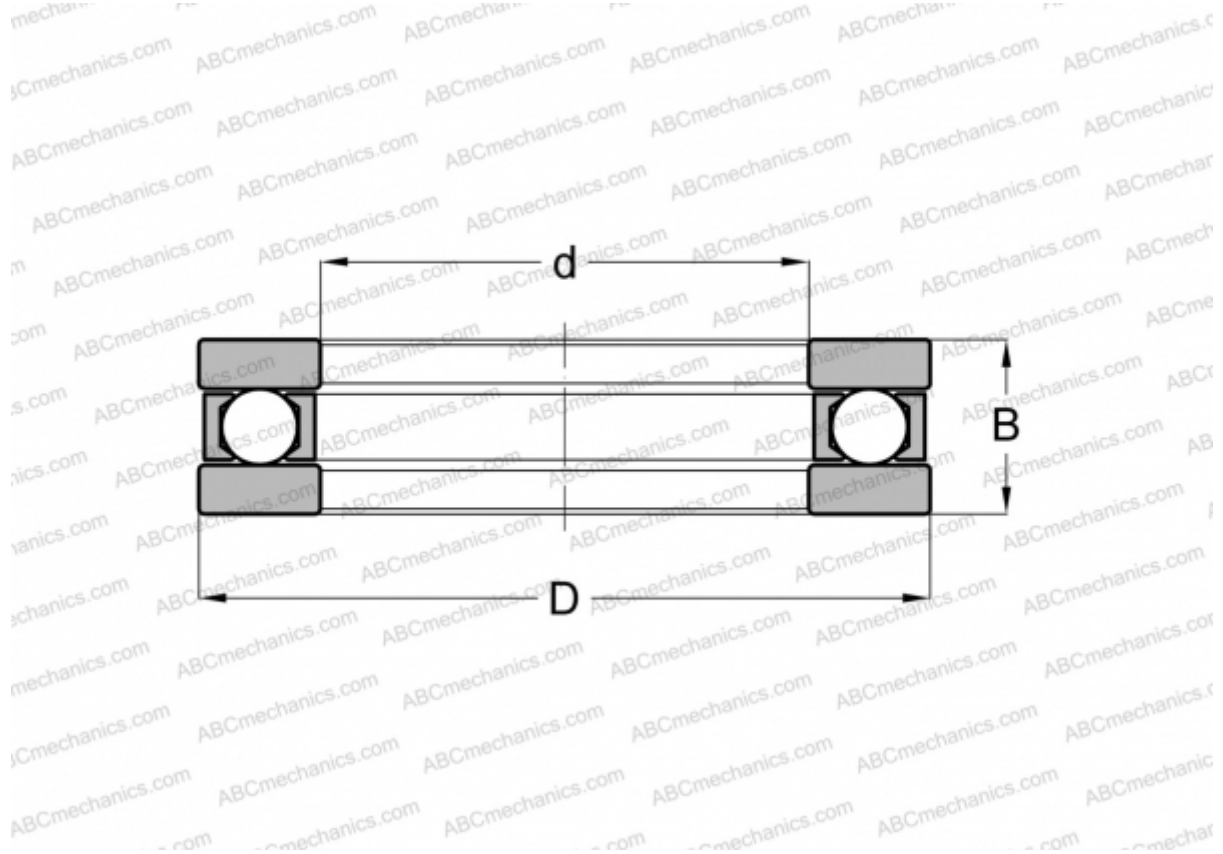

Technical specification

DIMENSIONS, MM

d	33,338
D	59,530
B	15,875

WEIGHT, KG 0,215

MANUFACTURER [AETNA](#)

INTERCHANGE

INA	FT-14
ANDREWS	FT-14