

B-19 AETNA

Thrust ball bearings

TYPE: Ball bearings, Thrust ball bearing, Single direction, Separable, flat raceway, inch size

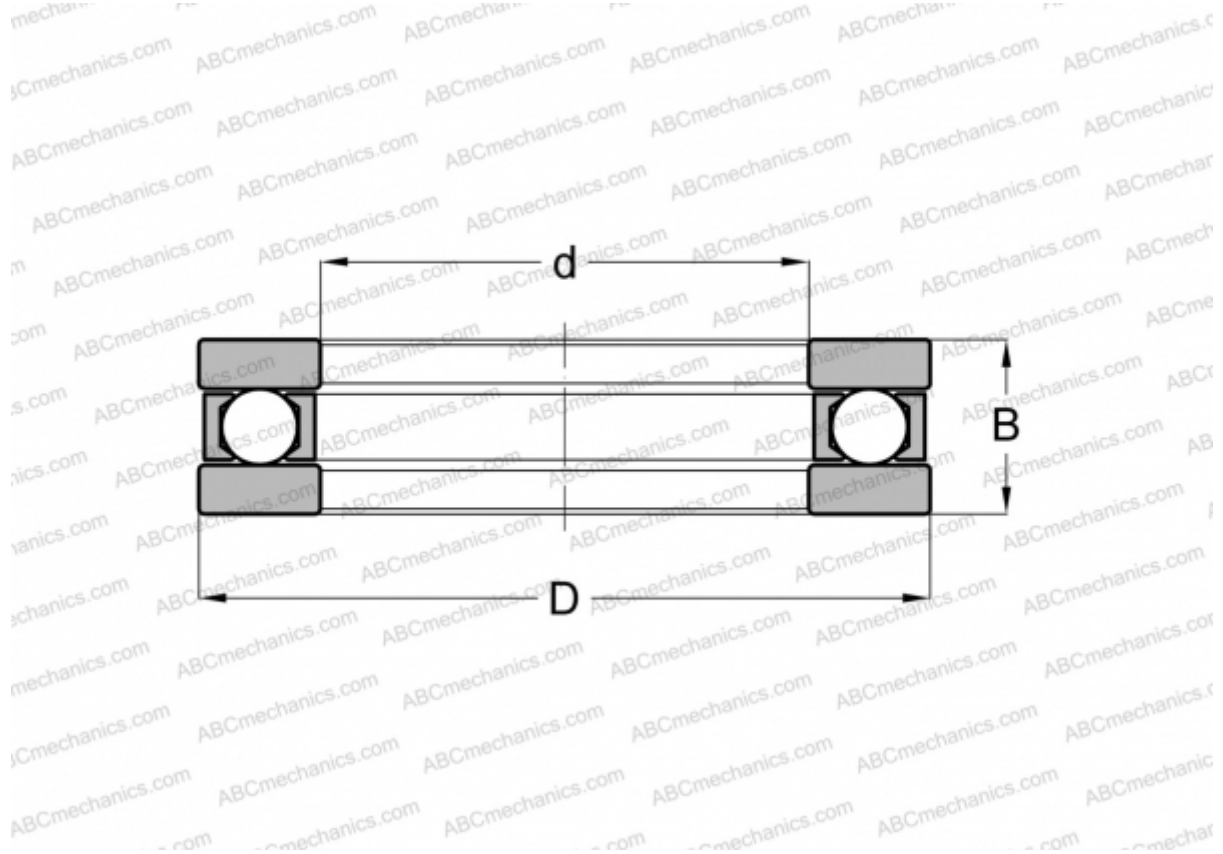

Technical specification

DIMENSIONS, MM

d	41,275
D	75,405
B	20,638

WEIGHT, KG 0,422

MANUFACTURER [AETNA](#)

INTERCHANGE

INA	FT-19
ANDREWS	FT-19