

B-21 AETNA

Thrust ball bearings

TYPE: Ball bearings, Thrust ball bearing, Single direction, Separable, flat raceway, inch size

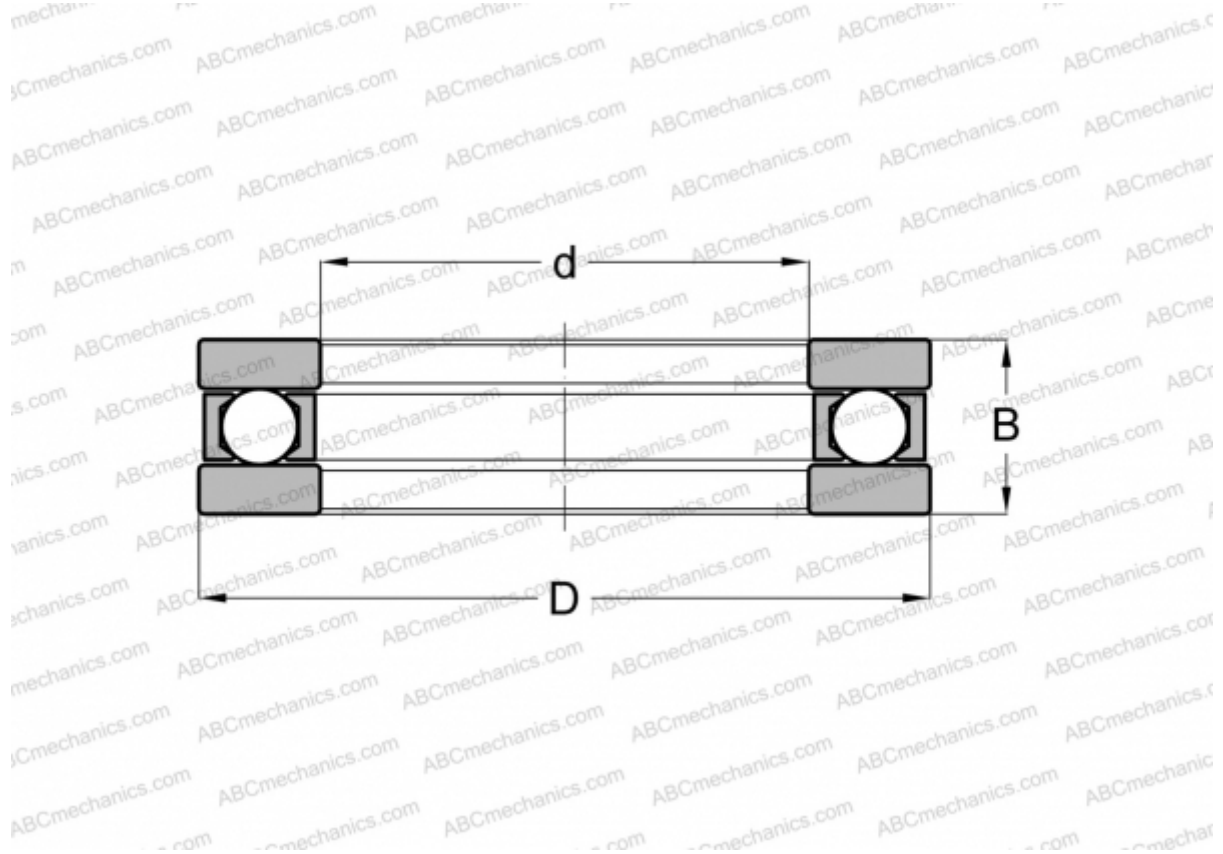

Technical specification

DIMENSIONS, MM

d	44,450
D	78,580
B	20,638

WEIGHT, KG 0,454

MANUFACTURER [AETNA](#)

INTERCHANGE

INA	FT-21
ANDREWS	FT-21