

B-22 AETNA

Thrust ball bearings

TYPE: Ball bearings, Thrust ball bearing, Single direction, Separable, flat raceway, inch size

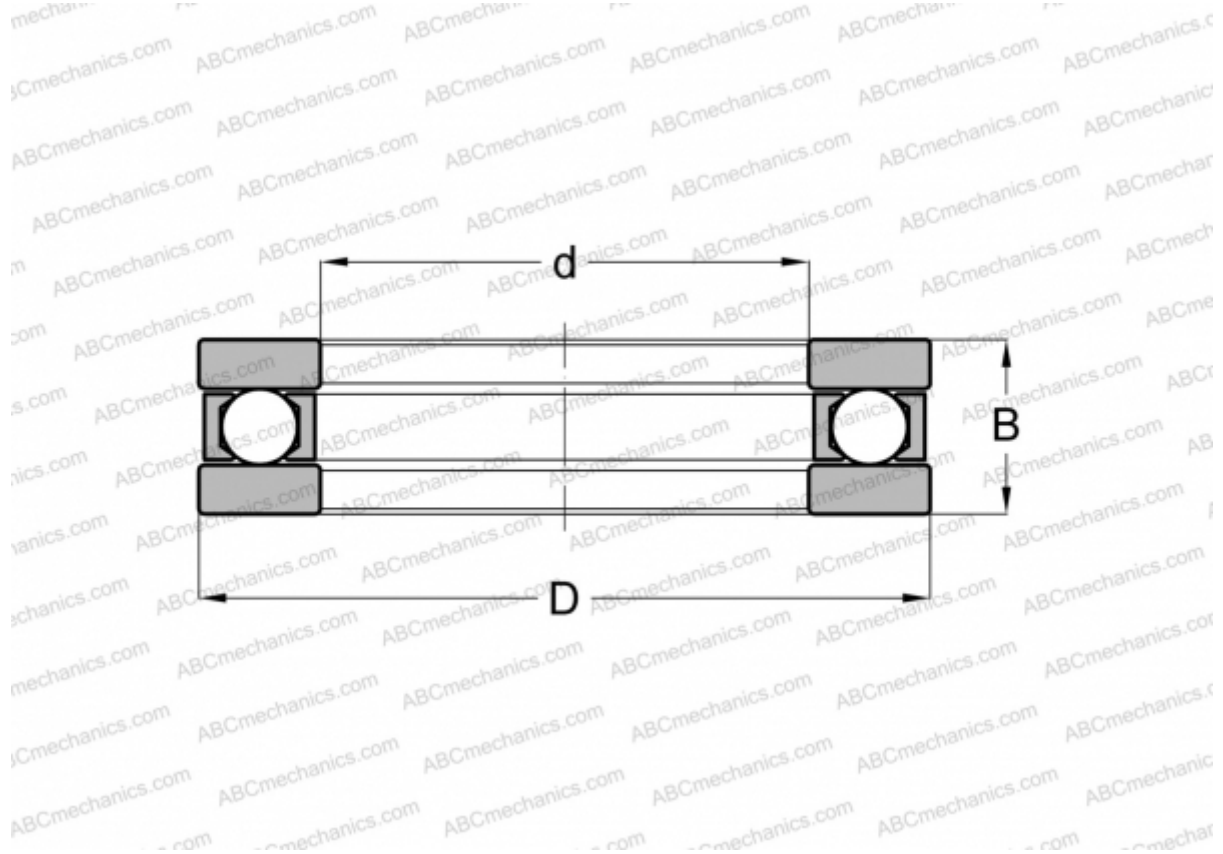

Technical specification

DIMENSIONS, MM

d	46,038
D	78,580
B	20,638

WEIGHT, KG 0,450

MANUFACTURER [AETNA](#)

INTERCHANGE

INA	FT-22
ANDREWS	FT-22