

B-31 AETNA

Thrust ball bearings

TYPE: Ball bearings, Thrust ball bearing, Single direction, Separable, flat raceway, inch size

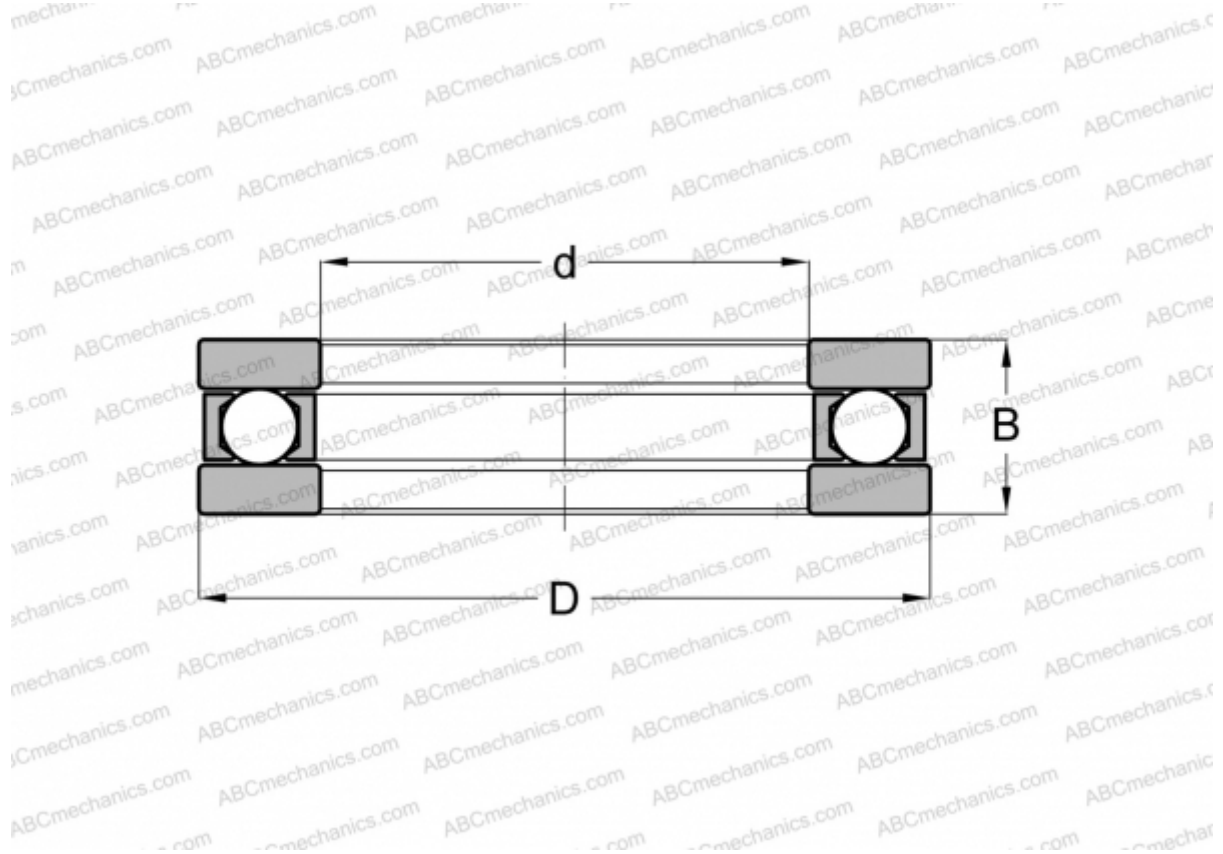

Technical specification

DIMENSIONS, MM

d	60,325
D	97,630
B	20,638

WEIGHT, KG 0,621

MANUFACTURER [AETNA](#)

INTERCHANGE

INA	FT-31
ANDREWS	FT-31